



Stonex Cube-a
Field Software
User Manual



cube-a
6.1

Summary

1. Introduction.....	7
1.1 Install and uninstall.....	7
1.2 Registration of the user license	7
1.3 Cube-a data storage.....	7
1.4 Cube-a first boot	9
2. Main Interface.....	10
2.1 Status Bar – GPS Module	10
2.2 Status Bar – TS Module	10
2.2.1 TS Control Panel	11
2.3 Menu Bar.....	14
3. Project	15
3.1 Project Manager	15
3.1.1 GIS Project	19
3.2 Project Details.....	22
3.3 File Manager.....	22
3.4 Point Library	23
3.5 Fieldbook.....	24
3.6 Import Raster Image	26
3.6.1 Raster image georeferencing.....	26
3.7 Import Data	28
3.7.1 Import a Cube-a Project or a *.PD file	28
3.8 Export Data.....	29
3.9 Feature Codes.....	29
3.10 Share by WiFi.....	30
4. Device – GPS Module	32
4.1 GNSS Status	32
4.2 Datalink Status.....	35
4.3 Communication.....	35
4.4 Working Mode.....	37
4.4.1 Static.....	38
4.4.2 Base	39
4.4.3 Rover	43
4.5 Datalink Settings.....	45
4.5.1 Internal Network.....	46
4.5.2 Internal Radio	47
4.5.3 Phone Network	48
4.6 Information.....	50
4.7 RTK Reset	50

4.8	Register.....	50
4.9	WiFi Mode Settings	51
4.10	Distance Meter	51
4.11	Utility Locator	51
5.	Device - TS Module	54
5.1	Total Station Communication	54
6.	Survey.....	55
6.1	Point Survey	56
6.1.1	GPS Survey.....	59
6.1.2	GIS Survey.....	59
6.1.3	TS Survey.....	60
6.2	Point Stakeout.....	61
6.3	Line Stakeout.....	63
6.3.1	Line Stakeout Settings	64
6.4	Stakeout by design lines	66
6.5	Elevation Control.....	68
6.6	Road Stakeout.....	70
6.7	Gridded Scan	70
6.8	View in Google Earth.....	73
6.9	CAD.....	74
7.	Survey Options.....	78
7.1	Display Settings	78
7.2	Layers.....	78
7.3	Background Map	79
7.4	Draw during the survey.....	80
7.5	Point type.....	81
7.6	Photos and Sketch	82
7.7	Survey Tools.....	83
8.	Configure	86
8.1	Coordinate System.....	86
8.2	User Coordinate Systems	88
8.3	Record Settings.....	88
8.4	Display Settings	89
8.5	System Settings	89
8.6	Survey Area Settings	90
8.7	External Drawings	91
8.8	Administration.....	91
8.9	DXF Symbol Library	91
9.	Calibrate - GPS Module	93
9.1	One Point Localization	93

9.2	Site Calibration.....	94
9.3	Calibrate Point	96
9.4	Change Station Coordinates	98
9.5	Sensor Options	98
9.6	Calibrate Sensor.....	99
9.7	RMS Study	101
10.	Calibrate - TS Module	103
10.1	Station on point	103
10.2	Resection/Free Station	107
11.	Tools.....	112
11.1	Entity List	112
11.2	TIN List	113
11.3	Volumes.....	117
11.4	Coordinate Converter.....	118
11.5	Angle Converter	119
11.6	Perimeter and Area	120
11.7	COGO Calculations.....	120
11.8	Version and Update	121
11.9	WMS Server	122
11.10	Rescan Folders	122
12.	Appendix A - CAD Tools.....	124
13.	Appendix B - Road Stakeout.....	134

1. Introduction

Cube-a is a Stonex field software for professional surveying and GIS which has been designed and developed for the Android platform. Thanks to the flexibility of the Android environment, the user interface is very simple and intuitive, and this makes surveyors ready for any work, saving time and increasing productivity. With Cube-a is possible to perform a GNSS, GIS and Total Station survey. The software can be installed on any device equipped with Android operating system.

This manual introduces all the functions available in Cube-a software.

1.1 Install and uninstall

This paragraph describes how to install and uninstall Stonex Cube-a.

Install

- I. Download the file with extension *.apk for installing the software and copy it into the internal memory of the Android device.
- II. Click on the apk file from your Android device to start the installation, and then click *Install*.

Uninstall

There are two possibilities to uninstall Cube-a:

- a) Hold down the Cube-a icon on the screen, click *App info*, then click *Uninstall*.
- b) Go to Android device settings, click *Apps & notifications*, then search for Cube-a application. Select Cube-a, then click *Uninstall*.

1.2 Registration of the user license

You need to know your personal license code, it looks like A06000000000000000. The software cannot be unlocked without entering the correct license code.

Follow the steps below to register your license.

- I. Start the software.
- II. Read the end user license agreement.
- III. Click *Accept* if you accept the contract, otherwise click *Decline* to terminate the application.
- IV. Fill out the data form correctly and click *OK*.

Note: you cannot use the same purchase code to unlock a copy of the program that is installed on another device. For this, you need to purchase an additional license (so, you will get another different license code).

If you have any problem activating the program, please contact your local dealer.

1.3 Cube-a data storage

As soon as you install the program, the StonexCube folder is created in the device internal memory; within the latter there are several folders whose use is summarized in the following table.

/StonexCube/Config	Configuration files. Do not change it!
--------------------	--

/StonexCube/Config/Codes	The folder where Cube-a looks for and stores codes libraries.
/StonexCube/Config/Symbols	The folder where Cube-a looks for and stores point symbols.
/StonexCube/Coordinate	The folder where Cube-a looks for coordinates files (for survey area settings).
/StonexCube/Export	The folder where Cube-a stores exported files.
/StonexCube/Geoid	The folder where Cube-a looks for geoids; copy geoid files here if they are not already included in Cube-a.
/StonexCube/GISFeatureSets	The folder where Cube-a looks for files for GIS attributes; copy the files here for the new GIS tabs (.xml files). We suggest using the integrated Feature Set Editor to create new attribute tabs or modify the existing ones.
/StonexCube/Input	The default folder where Cube-a looks for the data you want to import; you can copy the files you want to import here or in other folders.
/StonexCube/ItalyIGM	The folder where Cube-a looks for grid files (*.gr1/gr2 and *.gk1/gk2/gk3); only for Italy.
/StonexCube/Map	The default folder where Cube-a looks for external drawings you want to import; you can copy the files here or in other folders.
/StonexCube/Project	The projects storage folder.
/StonexCube/RefSys	Internal configuration files. Do not change it!

For each project, Cube-a creates a folder with the same name of the project, within the Project folder.

For example, considering that the project name is "MyProject1", the resulting structure of the subfolders in the project folder will be as described in the following table.

/StonexCube/Project /MyProject1	Project folder that contains subfolders, described below, and configuration files. Do not modify the configuration files.
/StonexCube/Project /MyProject1/Config	Configuration files. Do not change them!
/StonexCube/Project /MyProject1/Data	Survey files (files *.PD).
/StonexCube/Project /MyProject1/Log	NMEA messages or TS log files if the debug function is enabled (see 4.3 Communication).
/StonexCube/Project /MyProject1/Photos	Photos taken during the survey.
/StonexCube/Project /MyProject1/RawData	<p>If the controller is equipped with an internal GNSS which allows the raw data recording (for example Stonex S70G) this folder will contain the raw data to be used in the post-processing.</p> <p>Raw data is recorded only if you enable the option.</p> <p><u>Note:</u> raw data of external GNSS receivers are stored in the internal memory of GNSS and not in the handheld.</p>

1.4 Cube-a first boot

The first time you open the software, you are prompted to create a project. Each time the user creates a new project in Cube-a, a folder with the same name is created in the device memory (File/StonexCube/Project) where there are all project data, the surveys, all photos associated to the points, etc.

Each time the user creates a new project, Cube-a automatically creates a file with extension *.PD, with the same name of the project, in the Data folder in the project folder (File/StonexCube/Project/Data); PD is the extension of the surveys created with Cube-a.

2. Main Interface

The main interface of the software consists of the Status Bar always visible at the top and the Menu Bar at the bottom, described in detail in the following paragraphs.

The Status Bar is always visible, even switching menus, and is continuously updated in real time, based on the signal received and the location of the instrument you are connected to. It looks different depending on whether you are in GPS mode or Total Station mode.

2.1 Status Bar – GPS Module

In the GPS mode, the status bar is as follows.





1. The name of the current Project and the PD file currently in use (see [3Project](#)).
2. Indicator of conformity to tolerances set by user (see [7.5Point type](#)).
 - a. Green: tolerances respected.
 - b. Red: tolerances not respected.
 - c. Yellow: tolerances respected only in part.
3. Horizontal and vertical root mean square (see [4.1 GNSS Status](#)).
4. Type of solution (see [4.1 GNSS Status](#)).
5. Number of satellites used/ number of satellites visible.
6. Data transmission mode (see [4.5 Datalink Settings](#)) and age of differential corrections (see [4.1 GNSS Status](#)).
7. GNSS receiver battery/ batteries level.
8. Switch to Total Station mode.
9. Local or geodetic coordinates of the current position (click to switch between views).
10. Pole tilt angle (available only if connected to a receiver equipped with IMU technology and with active tilt correction). Hold down to enable or disable the sensor (see [9.5 Sensor Options](#)).

2.2 Status Bar – TS Module

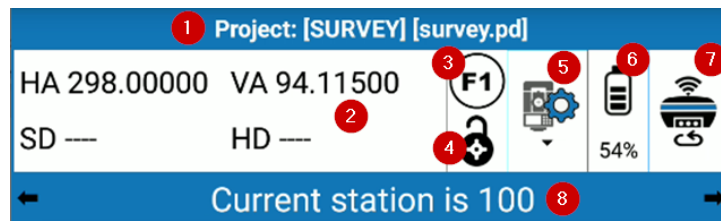
In the Total station mode, the status bar is as follows.



1. The name of the current Project and the PD file currently in use (see [3 Project](#)).
2. Measurements of the total station:
 - HA -> horizontal angle.
 - VA -> vertical angle (by clicking on the angle you can view it as a percentage).
 - SD -> slope distance.
 - HD -> horizontal distance.
3. Face of the station in use. Click to rotate the total station.
 - a. F1 left face.
 - b. F2 right face.
4. Prism state:
 -  the prism is not locked.
 -  looking for prism.
 -  prism is locked.
5. Click to access to the control panel of the total station (see [2.2.1 TS Control Panel](#)).
6. Total Station battery level.
7. Switch to GPS mode.
8. Name of the current station (click on the name to see the coordinates of the point).





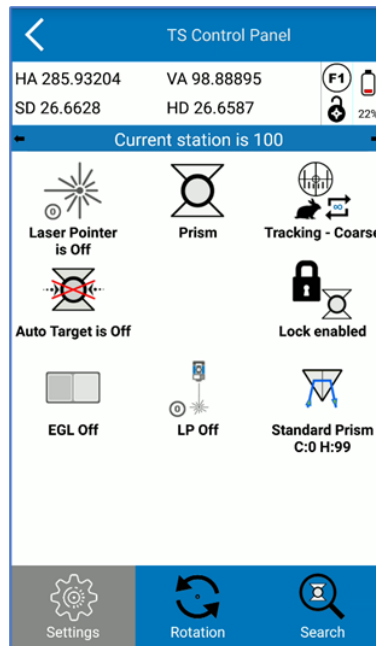







2.2.1 TS Control Panel

The TS control panel contains three submenus, Settings, Rotation and Search, depending on you are working with the motorized total Station, or you are working with a manual one.











Total Station settings

Define the total station settings. They can change depending on the total station model used.

- Laser pointer: can be turned off/on  
- Target type:
 - No Prism if you are surveying points without prism 
 - Reflector if you are measuring a point identified by a reflective sheet 
 - Prism up to 2,500 meters 
 - Remote prism between 2,500 and 5,000 meters 
- Measuring mode:
 - Single - Fine: the station will measure a single and precise measurement point 
 - Tracking - Fine: The station will continue to make precise measurements point, until it is stopped 
 - Tracking - Coarse: The station will continue to make fast point measurements point, until it is stopped 
 - Tracking - Coarse + Fine Shot: The station will continue to make fast measurements until a precise measurement is made 
 - Average (3): the station will survey 3 points measurements and Cube-a will average them. 
 - Average (n): the station will survey *n* points measurements and Cube-a will average them. 



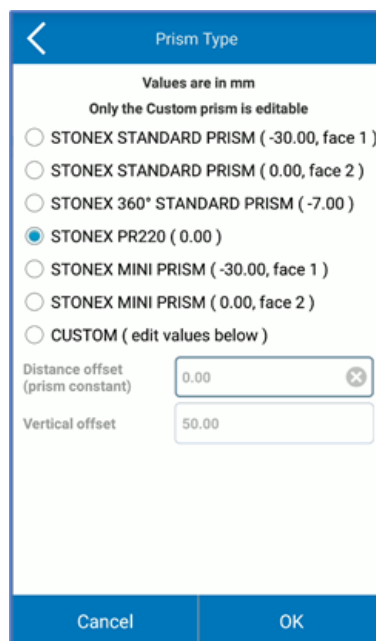

Press over the icon to enter as many measures as you want 

- Target Auto: Can be enabled  /disabled . If enabled, corrects target aim with respect to the target axis. Calculates angular corrections (horizontal and vertical) to correct angles without having to aim exactly at the center of the prism. If Autotarget is enabled, the Lock is disabled and vice versa.
- Lock: Can be enabled  / disabled . It makes sense to enable it if you are using a prism as a target.
- Electronic Helpline: Can be enabled (3 levels available)  /disabled. 
- PL (Laser Plummet): Can be enabled (3 levels available)  /disabled .
- Prism Type : Select the prism model from the list or choose CUSTOM to insert the desired offset values.

NOTE: Since the vertical offset of the prism is defined on this page, this value should not be considered by setting the height of the measure during the Survey but inserting the height of the pole only.









Total station rotation

From here you can manage the motorized station remotely. You can rotate the telescope up  /down  /left  /right ; movements can be stopped by pressing stop. 

From this page you can also change the face of the instrument (from face I to face II and vice versa). 

Prism searching

From here you can manage the search for the prism with a motorized total station. You can start searching for the prism at the top  /bottom  /left  /right  or within larger and larger area , starting from where the telescope is positioned.

The Search Near GPS Location  and Search Near Point  allow you to rotate the telescope in the direction of the GNSS or the location of the point, respectively. They can be used during the survey, after the location of the station has been defined and its orientation Search near GPS location can be used if you have the Cube-a GPS module and if the antenna has the fixed solution.

Press anywhere on the screen to stop the search. If the prism search is successful and lock settings are enabled, the prism will remain hooked.

2.3 Menu Bar

The menu bar, at the bottom of the screen, allows you to access the six main menus of the software.



Project: Project management and sharing, import and export.

Device: Connection and configuration of the GNSS receiver and the total station.

Survey: Point and line survey and stakeout, CAD environment.

Configure: Coordinate reference system, system settings, external drawings import.

Calibrate: Site calibration, total station calibration, calibration of the electronic bubble and tilt.

Tools: COGO and volume calculations, Cube-a updates.

These features are described in detail in the following chapters.

3. Project

In this menu there is everything related to project management, import and export of data and point code libraries.

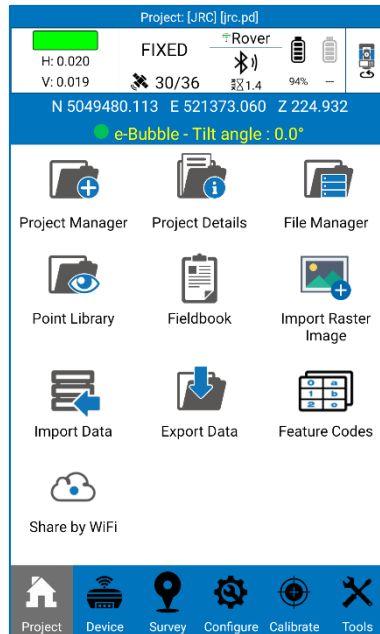

Each project can contain multiple PD files, so multiple surveys. Once the program is launched, you are automatically in the last project and in the last used file; Cube-a always opens a project, whose name is always visible in the status bar at the top.

Whenever you create a new project in Cube-a, a folder with the same name is created in the device memory (File/StonexCube/Project) in which there are all project-related data, surveys, any photos associated with points, etc.

3.1 Project Manager

This page contains the list of the projects.

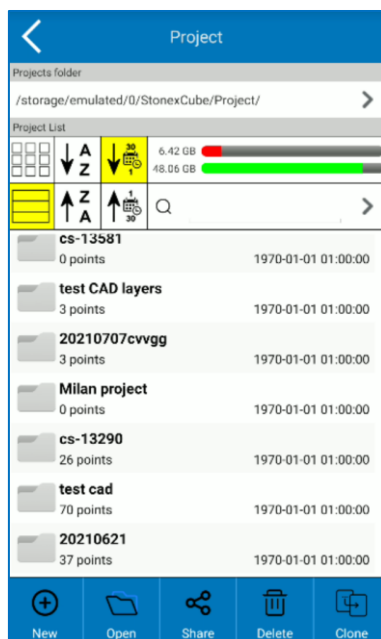

At the top there is the path where you can find all projects visible below in the project list; you can click on the arrow on the right to change the path. In the Project List section, there are as many folders as there are projects created or imported in Cube-a; you can sort these projects alphabetically or by creation date using the following icons.

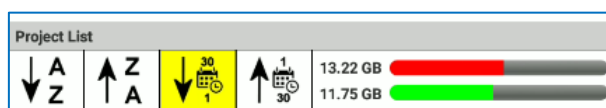

On the right is visible the memory space used in red and the free space in green.

You can see the projects in a grid view or in a list view, using the following icons.

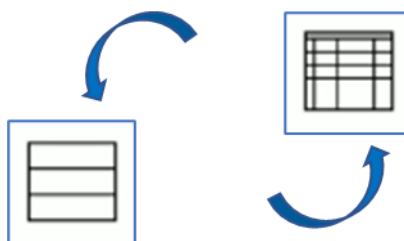

The search bar immediately under the memory bar allows you to search for projects by typing the name and by clicking on the arrow on the right. After searching for projects, click on the cross and again on the arrow on the right to go back and view all projects.

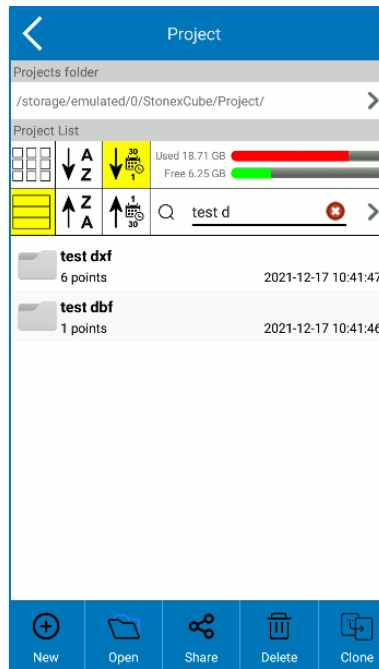

The icons at the bottom bar are described in the following list.

- New: Create a new project.
- Open: Open a project after selecting it in the list.
- Share: Share the selected project through the communication channels shown below.
- Delete: Delete the selected project.
- Clone: Duplicate the selected project.

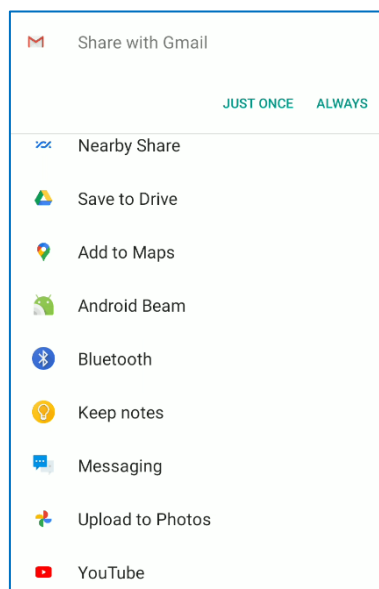

By clicking **New** it opens the following window.

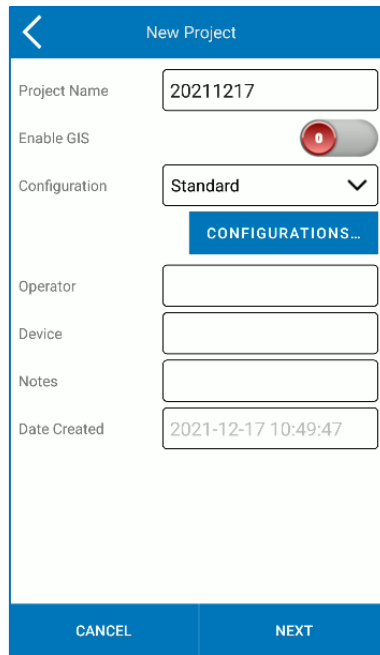

The default project name is the project creation date, but you can change it by simply clicking on the name bar. In Cube-a, you can no longer change the name of the project, you can assign a different name only when you export. All other fields are optional.

The Enable GIS feature is visible only if you have the GIS module and is disabled by default; see section [3.1.1 GIS Project](#) for more information.

In the drop-down menu *Configuration*, there are the standard configuration already included in the program and all the ones created by the user. Click on the blue key *Configuration* to create a new configuration.

Configuration means the symbol library and layers that can be used in the project. Example: if the user usually uses a dozen of layers defined in the same way each time, is not convenient to recreate them for each project, is instead very useful create a new configuration included these layers (defined so one time) and so recall that configuration for each project in which it is to be used.

By clicking *Cancel*, the project is not created. Click *Next* to continue the project creation.

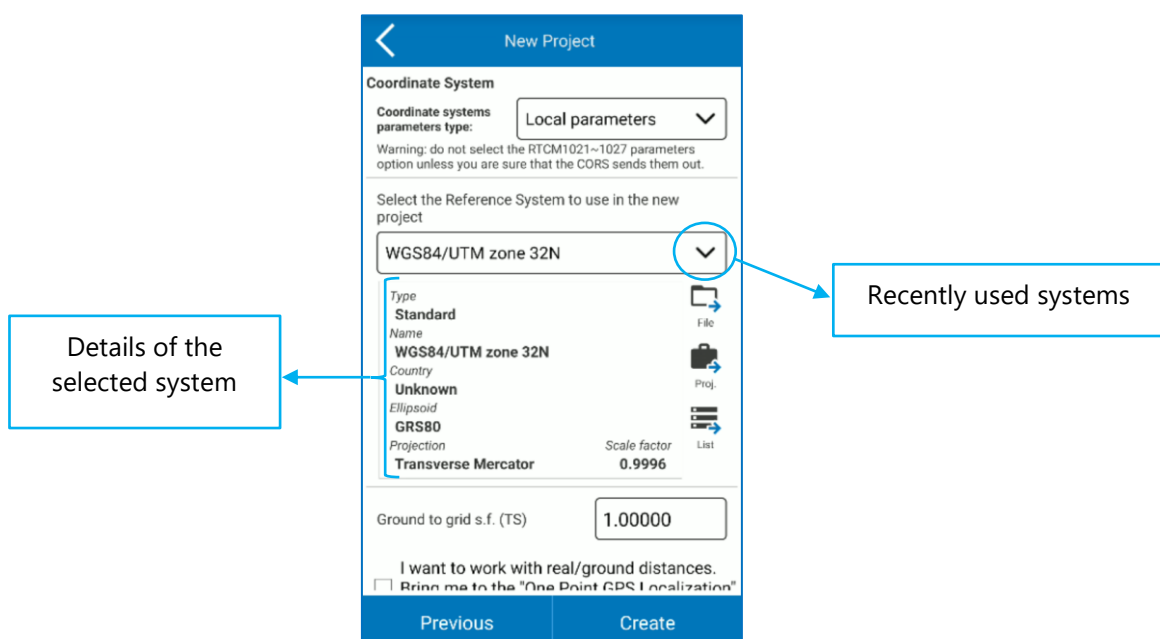

Coordinate System

Coordinate systems parameters type: Local parameters

Warning: do not select the RTCM1021~1027 parameters option unless you are sure that the CORS sends them out.

Select the Reference System to use in the new project

WGS84/UTM zone 32N

Type: Standard

Name: WGS84/UTM zone 32N

Country: Unknown

Ellipsoid: GRS80

Projection: Transverse Mercator

Scale factor: 0.9996

Ground to grid s.f. (TS): 1.00000

I want to work with real/ground distances.

Bring me to the "One Point GPS Localization"

Previous Create

In the Coordinate System section at the top, you can select RTCM 1021-1027 messages if the CORS you use sends them out. Warning: if you are operating in Italy, do not select the "RTCM1021-1027" option in the *Coordinate system parameters type* drop-down menu, because they are not provided by the Italian permanent stations.

Select the coordinate system you want to use in the new project.

Click *File* to import an external coordinate system: the compatible formats are *.SP, *.JXL.

Click *Project* to take the coordinate system from an existing project.

Click *List* to select the coordinate system from the list of predefined reference systems that you already find in Cube-a; you can search the system by country or key words.

The scale factor from ground to grid allows you to adapt the measurements made with total station to the active reference system. For example, if the projection adopted is UTM then the scale factor is 0.9996.

Check the following option to perform a "one-point localization" as soon as you create the project. See [9.1 One Point Localization](#) for more information.

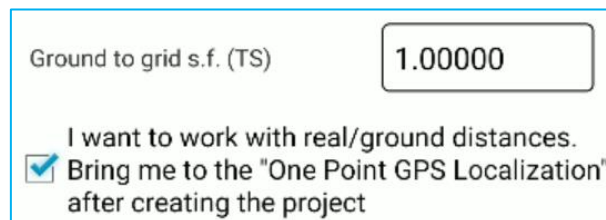

Ground to grid s.f. (TS)

I want to work with real/ground distances.

Bring me to the "One Point GPS Localization" after creating the project

Click *Previous* to back to previous page (project name, symbol library...).

Click *Create* to create the project.

3.1.1 GIS Project

If you have the GIS module, you can enable the GIS function when you create a project, or later from *Project Details* menu. If you enable the GIS function, the Activate GIS Feature Set Repository window appears. Here you can select a group of GIS features from the drop-down menu to use it in the current project (select it and click *OK*), or to edit it (select it and click *Edit*), or to clone it (in this case you can modify the clone without changing the existing one) or delete it.

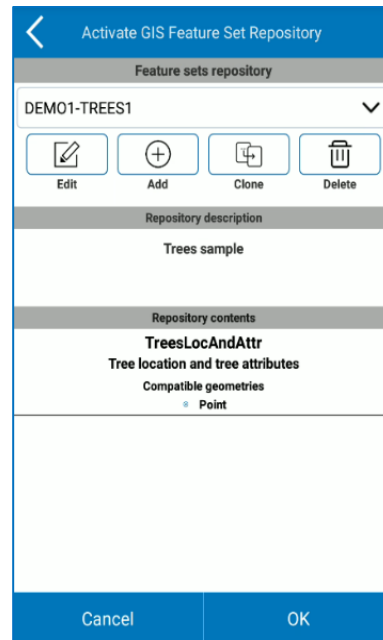
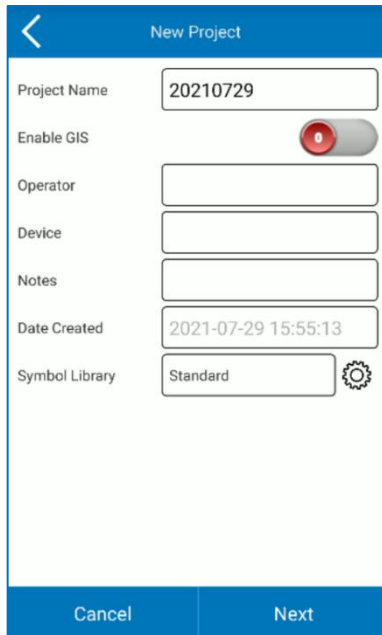

If you want to import a GIS features group, you must copy the group in XML format in the following folder: Internal Memory -> StonexCube -> GISFeatureSets. Then you will see the group in the drop-down menu. In the same folder you can find some sample files.

You can create a new group in Cube-a: click *Add* and type the name you want. The new group appears in the drop-down menu, and then select it and click *Edit* to create the group contents and GIS attributes.

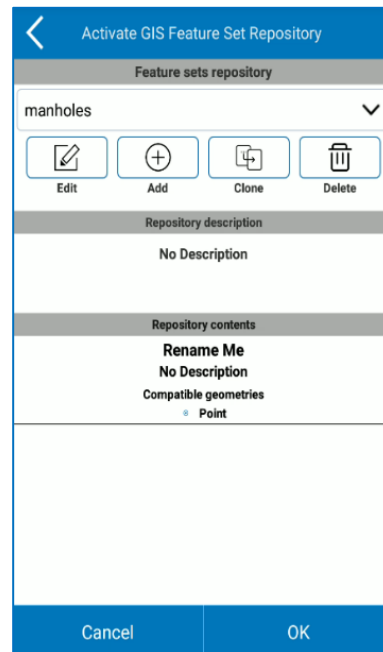
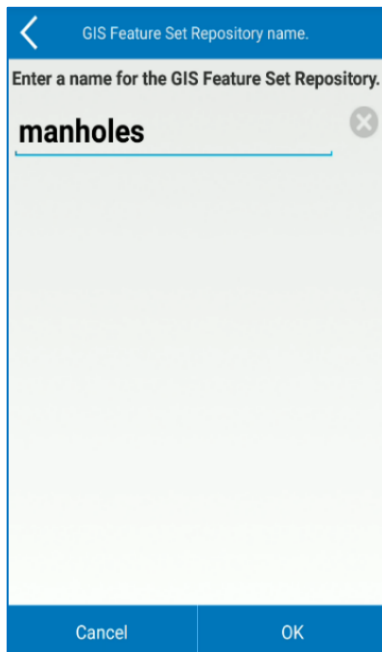

In the group description box, you can add a description for the previously selected GIS features group if desired. When you create a new group, a class is displayed by default, its name is "Rename me"; select this one and click *Edit* to change the name and create the list of attributes for this class.

Click *Add* to add a new class. Click *Delete* to delete the selected class. Click *Cancel* to undo the changes. Click *OK* to confirm the changes and return to the "Edit GIS Feature Set Repository" window.

If you select a class from “Repository contents” and click *Edit*, the “Edit GIS Feature Set” window appears. Here you can change the name and description of the class, select compatible geometries, and create or edit the list of attributes, the Feature List.

When you create a new class, an attribute appears by default, its name is "F1", then select this and click Edit to change the name and customize it.

Click *Add* to add a new attribute to the current class. Click *Delete* to delete an attribute in the current class

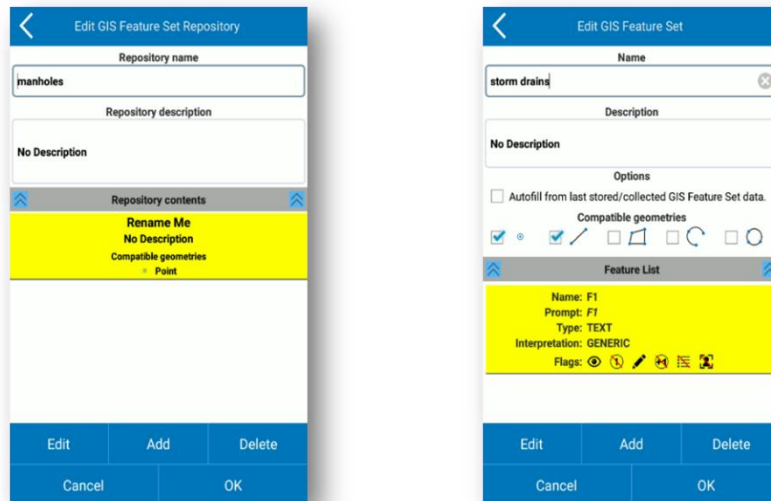

If you select an attribute from the attribute list (Feature List) and click *Edit*, the “Edit GIS Feature” window appears. Here you can change the name and the prompt for the attribute, data type, enter a list of values, and other options. You can create a list of values in Cube-a: select “Given List” from the drop-down menu, then click the pencil, and the “Edit value list” window appears.

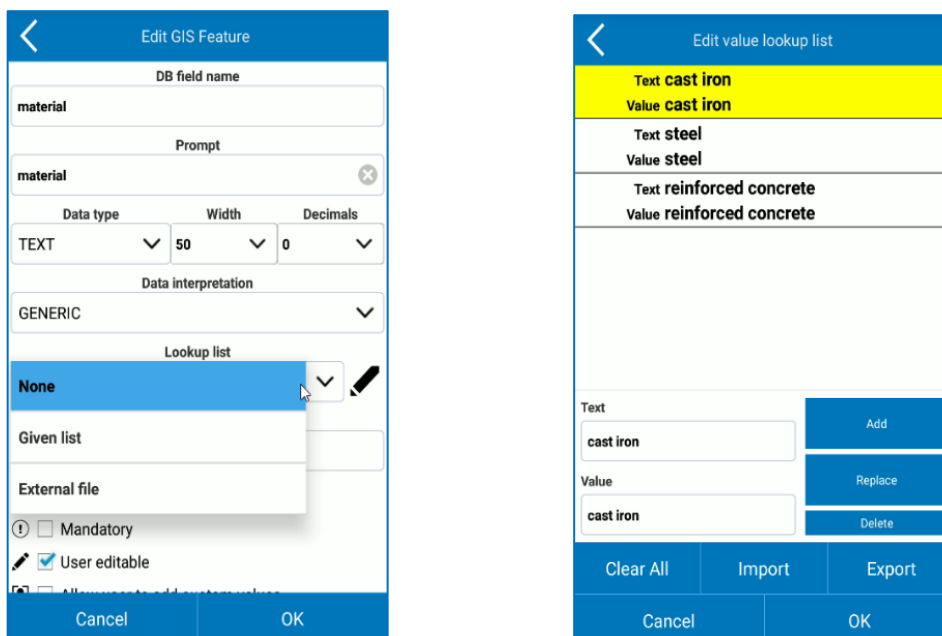

3.2 Project Details

In the *Project Details* submenu, the user can verify and edit some details of the current project. In this page, the user can enable the GIS function if it was not activated during project creation or turn it off. If the function is enabled, after clicking OK, you can select or edit the GIS feature group.

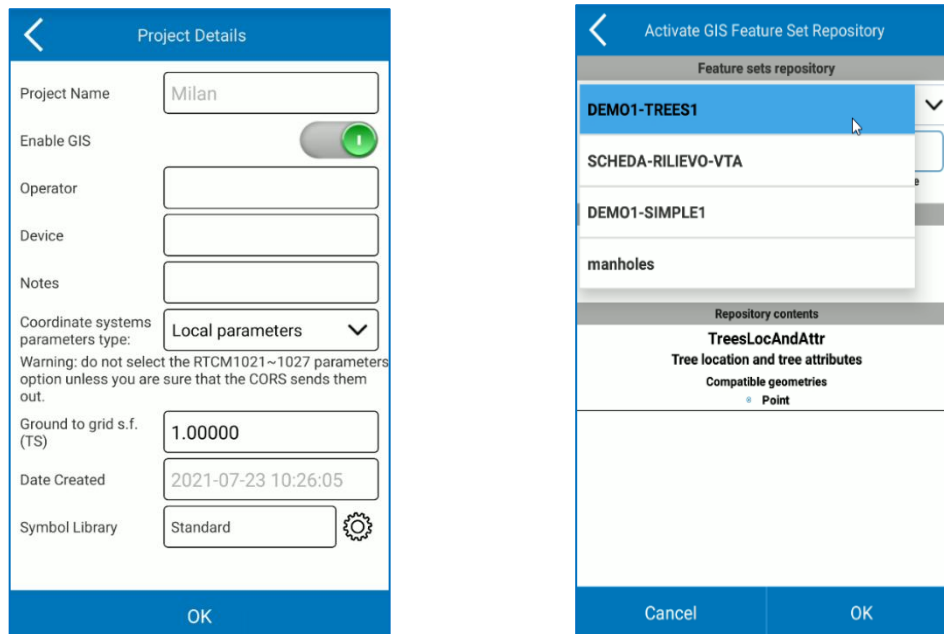

3.3 File Manager

As anticipated in the previous paragraphs, a project can contain multiple surveys. In the *File Manager* submenu, you will find all the .PD files, then the various surveys contained in the current project. Each time the user creates a new project, Cube-a automatically creates a .PD file with the same name as the project. In this page you can add new .PD files to the current project, or open or delete an existing file after selecting it. Once created, you cannot change the file name in Cube-a, you can only do it during export.

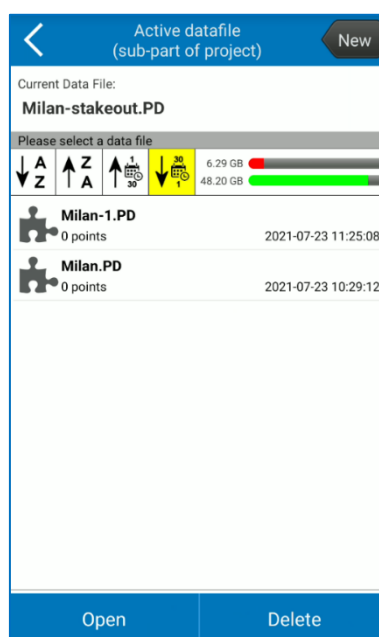

3.4 Point Library

In the Points Library submenu, you will see the list of all points that are surveyed, calculated, imported, and added manually. You can switch from List view to Grid view by clicking on the icon at the top left shown in the following figures.

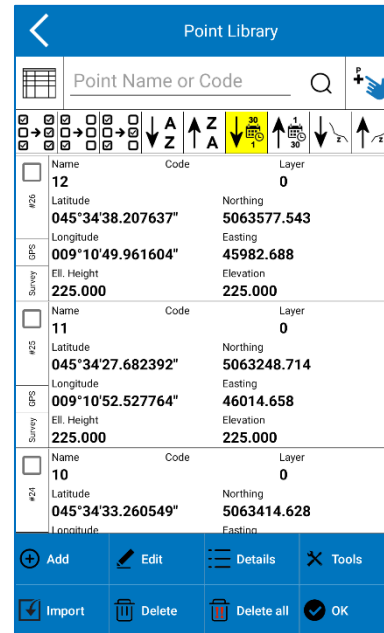
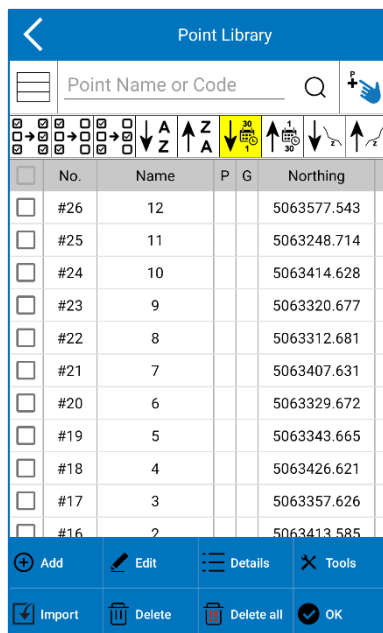
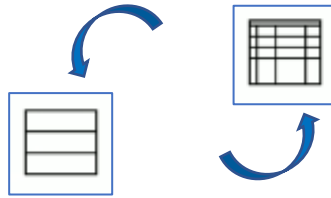

You can search for a point by filtering the search by name or code or select it directly from the survey area by using the “select point” icon represented by a blue hand that indicates (icon in the upper right).

You can select or clear multiple points at the same time and reverse selections using the selection icon in the upper left.

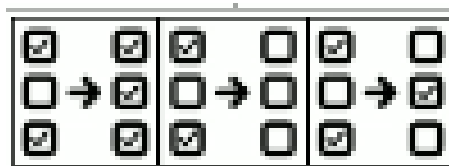

After selecting a point, you can see the details of the point, edit it or delete it using the functions in the bottom bar. From the latter you can also add new points by clicking Add and access the Import Data submenu by clicking *Import*.

By clicking *Add* opens the following window where you can add a point by entering local or geodetic coordinates.

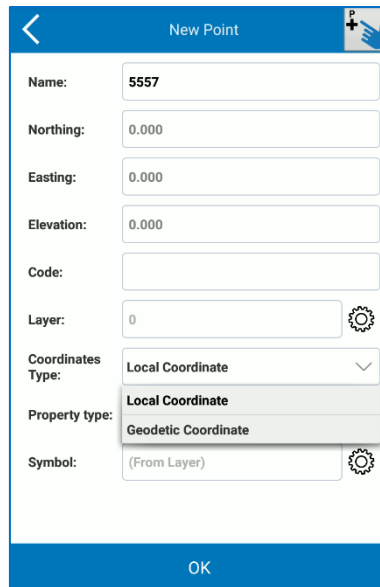

All points can be sorted by name, acquisition date, or elevation using the following icons in the upper right.



3.5 Fieldbook

In the page *Fieldbook* you can see the list of the GNSS bases with their baselines and the list of the Total Station bases (stations) with their measures, depending on your current job. This function will be available from the next version.

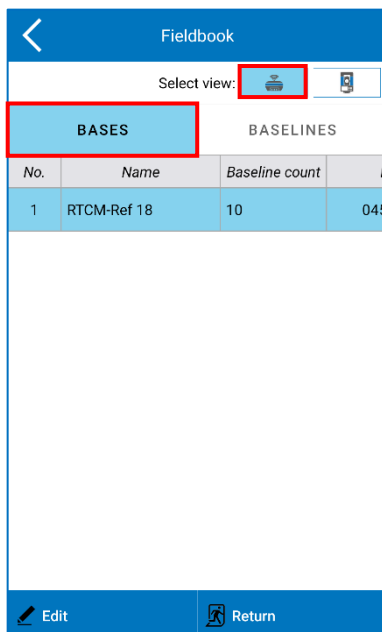

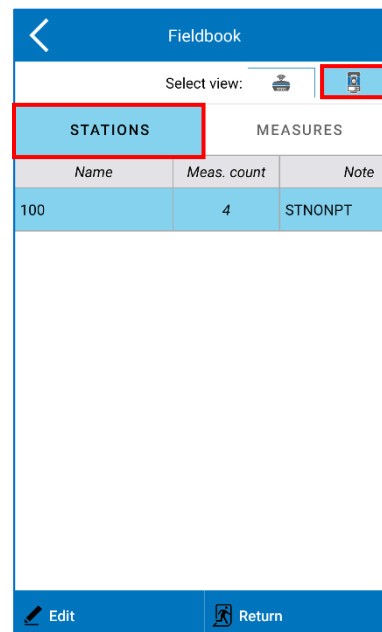

No.	Name	Baseline count	L
1	RTCM-Ref 18	10	045



Name	Meas. count	Note
100	4	STNONPT

Fieldbook

Select view:  



BASES **BASELINES**

Base: **RTCM-Ref 18**

No.	Name	Note
12	3	
13	4	
14	6	
15	7	
16	8	
17	9	
18	10	
19	11	
20	12	

Edit Return

Fieldbook

Select view:  



BASES **BASELINES**

Base: **RTCM-Ref 18**

Status	PDOP	GDOP	HDOP
FIXED	2.50	2.95	0.
FIXED	2.50	2.95	0.
FIXED	2.50	2.95	0.
FIXED	2.50	2.95	0.
FIXED	2.50	2.95	0.
FIXED	2.50	2.95	0.
FIXED	2.50	2.95	0.
FIXED	2.50	2.95	0.
FIXED	2.50	2.95	0.
FIXED	2.50	2.95	0.

Edit Return

Fieldbook

Select view:  



STATIONS **MEASURES**

Station: **100**

No.	Name	Note
1	101	
2	102	
3	103	
4	104	

Edit Return

Fieldbook

Select view:  

STATIONS **MEASURES**

Station: **100**

HA	VA	SD	Prism Hg
10.36185	100.00000	350.175	0.
100.82339	100.00000	390.510	0.
211.49049	100.00000	357.252	0.
304.08873	100.00000	374.461	0.

Edit Return

3.6 Import Raster Image

The Import Raster Image submenu allows you to import a raster georeferenced image. By clicking “Open Raster Image”, the default path is StonexCube → Input, but you can move to other folders.

Cube-a supports raster images in the following formats:

- Portable Network Graphics (PNG) – lossless compression.
- JPG (Joint Photographic Experts Group) – non-leak-free compress.
- TIF (Tagged Image File Format)– usually compressed, usually without data loss.

Having a raster image is not enough to have georeferencing: the raster image must have a "twin" file that stores georeferencing parameters. This file is called "Word File" and must be created using software that manages image georeferencing (e.g., Stonex Cube-desk).

The following table shows what type of Word file you need to store in the same folder that contains the raster image to import:

Raster file Format	Word File Format
*.PNG	*.PGW
*.JPG	*.JGW
*.TIF	*.TFW

Limits on raster import

Cube-a is developed on android operating system and must comply with its limits on memory allocation. One of these limitations is that any application does not have to allocate large blocks of memory and if an application does, it must release those memory blocks as soon as possible.

Taken from Android developer documents: "To allow multiple running processes, Android sets a strict limit on the size of the heap assigned to each app. The exact limit of heap size varies between devices depending on the amount of RAM available on the device. If your app has reached heap capacity and tries to allocate more memory, the system generates insufficient memory error".

All this means that you must be careful when trying to upload raster images. Although a raster image file appears to be small (a few megabytes) the same does not apply to the image data that it contains. Remember that raster image files are usually compressed, and that Cube-a must uncompressed them before viewing them, and this may require more memory than the Android operating system can provide.

As a rule: an image of L x H pixels in size (width x height) needs a free amount of free memory equal to: L x H * 3 bytes.

Example: a photo of 5 mega pixels (2560 x 1920) occupies, after decompression, 14745600 bytes or 14 megabytes.

3.6.1 Raster image georeferencing

When you import a raster image, you can perform the georeferencing in Cube-a, by clicking on georeferencing option as in the following figure.

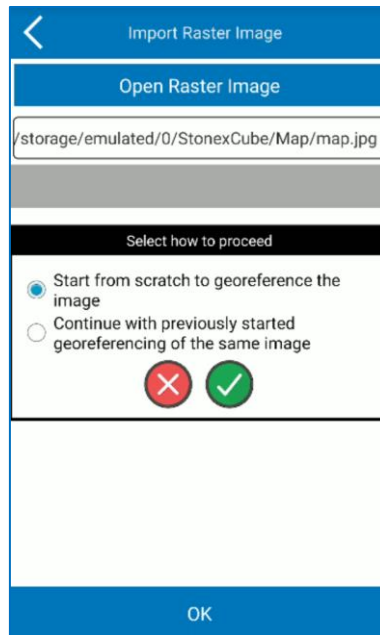

You need 4 points couples at least to perform the georeferencing. You need to associate the coordinates to 4 points not aligned at least in the raster image. You can take the coordinates from point library, from current GNSS position or from survey area.

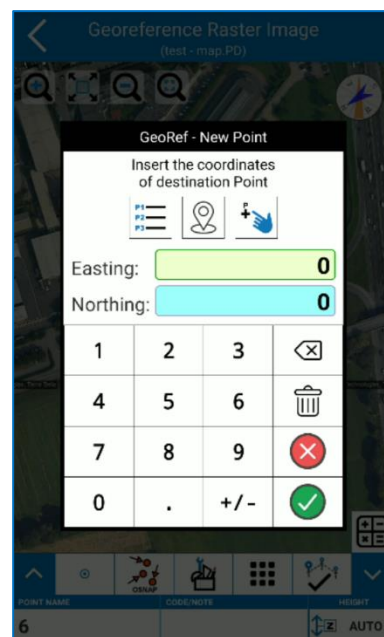

Click *calculate* icon below on the right to see the list of point couples and residuals.

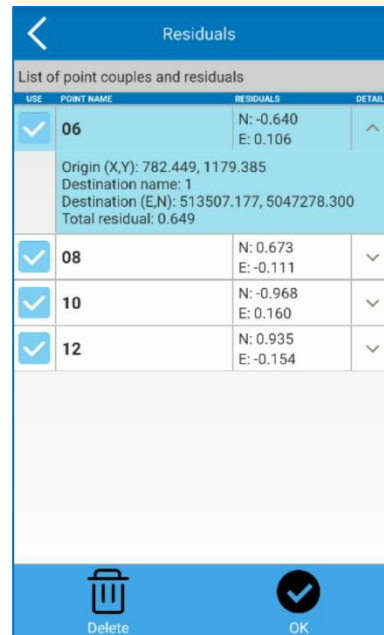

Click OK in the *Residuals* page to perform the georeferencing.

3.7 Import Data

In the Import data submenu, you can import external files that were previously uploaded in your device in various formats as in the following figures.

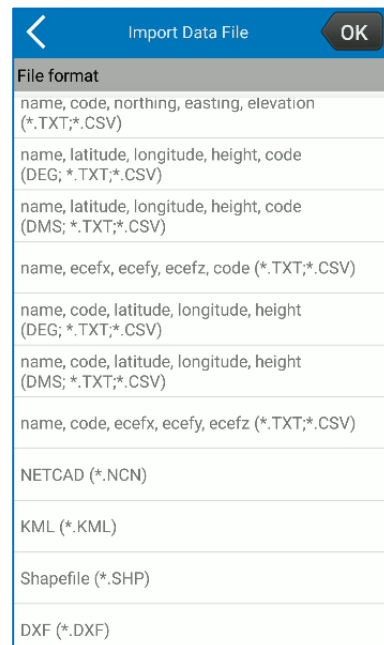
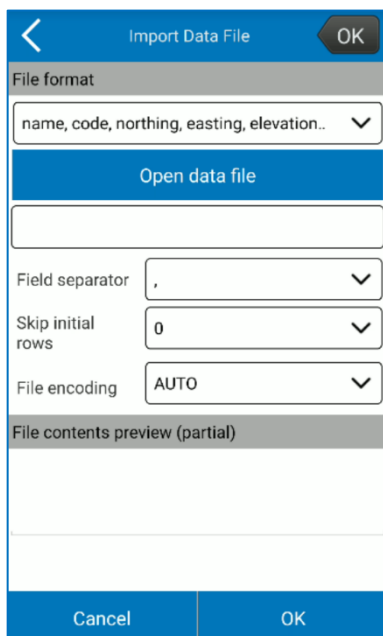

At the bottom you can see the preview of the file you are importing so that you choose the field separator correctly and whether to skip the start lines because of the header.

3.7.1 Import a Cube-a Project or a *.PD file

To import a project into your program, copy the project folder, as it appears, in the folder created by Cube-a, StonexCube → Project. The project will then be visible in the Project Manager submenu in the Project menu.

To import a *.PD file within an existing project in Cube-a, copy the *.PD file in the path StonexCube → Project → (Existing Project folder) → **Data**. Attention, if you do not copy the *.PD file in the Data subfolder then it will not be visible in the program. Once copied, select it from the File Manager submenu to open it in Cube-a.

3.8 Export Data

Export Data submenu is used to export the survey in a certain format, which is chosen by the user through the File type drop-down menu. You can export data in a default format or custom format. It is necessary to enter the name of the file you want to export, the survey (.PD file) and the format in which you want to export. Click *Export* to export the file to the export location shown at the top (click to edit the path if you want).

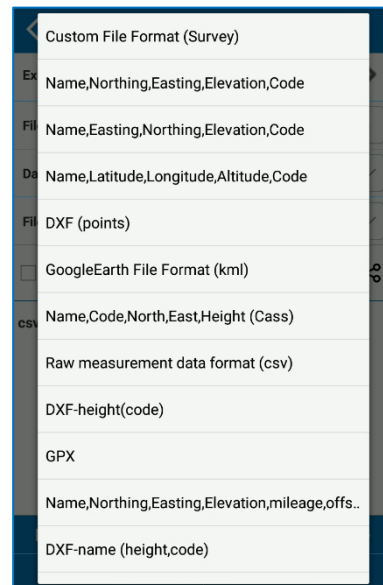
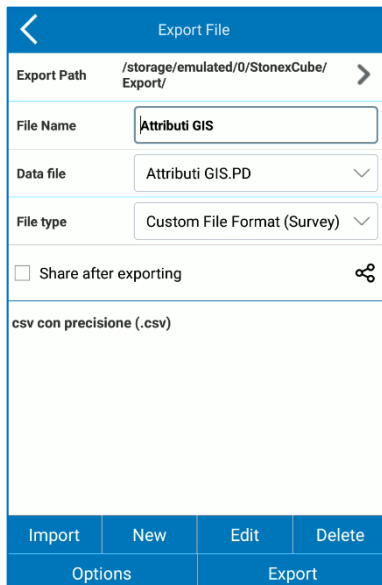

If you enable the “Share after exporting” option, before clicking *Export*, the same file that will be exported to the export location, it will also be shared in real time through the communication channel that will be chosen (e-mail for example).

3.9 Feature Codes

In the Feature Code submenu, you can manage point code libraries. There are already standard libraries, but you can add new ones by clicking *New* or edit those present by clicking *Edit*.

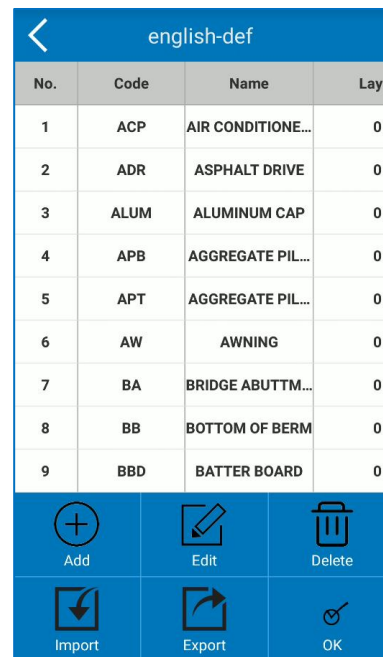
No.	Code	Name	Layer
1	ACP	AIR CONDITIO...	0
2	ADR	ASPHALT DRIVE	0
3	ALUM	ALUMINUM CAP	0
4	APB	AGGREGATE PIL...	0
5	APT	AGGREGATE PIL...	0
6	AW	AWNING	0
7	BA	BRIDGE ABUTTM...	0
8	BB	BOTTOM OF BERM	0
9	BBD	BATTER BOARD	0

You can create a new library in Cube-a, manually adding codes, or import it after copying it in your Android device. In the latter case, you can import a .fcl or .txt as in the following figure.

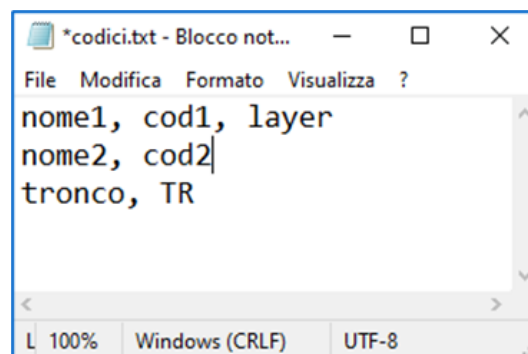

3.10 Share by WiFi

Through the “Share via Wi-Fi” submenu, the project can also be shared via Wi-Fi. This feature allows wireless connection between the Android device on which Cube-a is installed and the PC, to browse the contents present in the program and download the files from the device to the PC and vice versa.

On the Wi-Fi Sharing page, you must:

- Enter the device name (not required).
- Choose a username (the default username is "guest").
- Choose a password (the program shows by default a randomly generated numeric password, which can also be maintained if you prefer).
- Choose an IP port number whose value is in the range 1025-65535 (you can think of the port number as the home address while the IP address is the name of the street where the house is located).

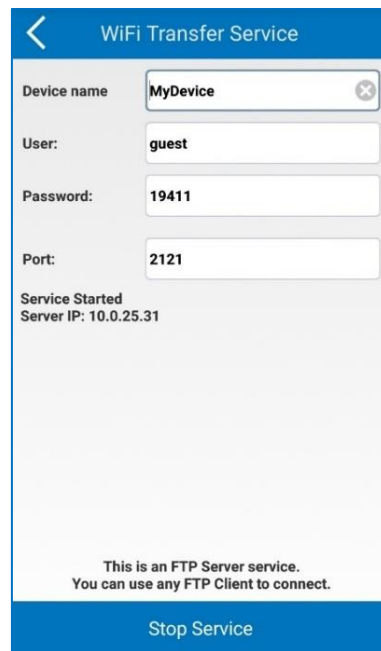

Before proceeding further, verify that:

- The Android device is connected to a Wi-Fi network.
- Your PC is connected, wirelessly or by cable, to the same Wi-Fi network to which your device is connected.

Note: If your Android device and PC are not connected to the same network, you cannot use the function, except if the network has been configured to allow communication between multiple networks (for example, if your company has more than one internal network).

When you are sure that all network constraints are satisfied, click *Start FTP Server*, after which the *Start FTP Server* key will change to *Stop FTP Server*.

Just below the “IP Port” field, the following messages will appear:

The FTP server service is running.

IP Server: AAA. BBB. CCC.DDD.

Where AAA. BBB. CCC.DDD is the IP address that must be entered later into the FTP client by PC. Note that the exact value of the IP address depends on the network: the common values for part AAA. BBB are 192,168 and 10.0 for local private networks.

After you set up the various settings correctly and start the “Share via Wi-Fi” feature from Cube-a, you need to follow additional simple steps from PC.

On the client (your PC) you can use any FTP client (such as FileZilla) to connect to the Android device.

4. Device – GPS Module

The Device menu contains all the functions concerning the communication and configuration of the GNSS receiver and the Total Station, in fact it looks different depending on the GPS or TS module, as shown in the following figures.

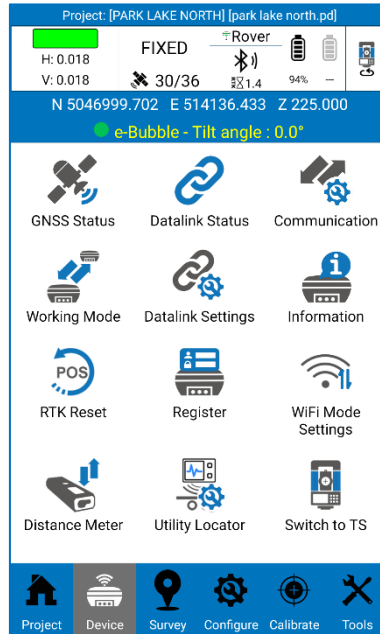

4.1 GNSS Status

The *GNSS Status* page contains the GNSS positioning information. You can even access to this page by clicking on solution/satellites on the status bar. The *Details* tab is shown in the following figure.

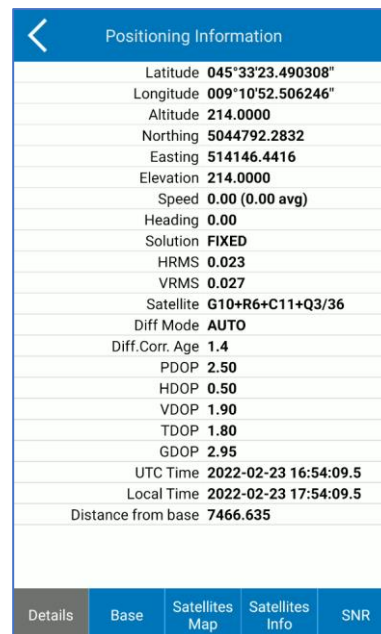
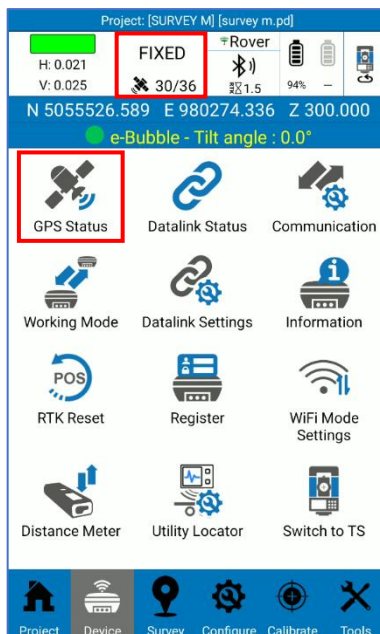

The **Solution** can be NO FIX, SINGLE, DGNSS, FLOAT, FIXED.

NO FIX: the GNSS position is not available (you are not connected to GNSS receiver, or the receiver does not see any satellites)

SINGLE: the GNSS is not receiving differential corrections from the base, so the accuracy is low.

DGNSS: the GNSS is receiving differential corrections from SBAS satellites, or from the base but it could not calculate a better solution; the causes can be various, e.g., a limited number of tracked satellites or slow data connection.

FLOAT: the GNSS is receiving differential corrections from the base, but the RTK algorithm has not been solved yet and it is always a less accurate position than a **FIXED** solution. It's a good solution for GIS surveys but not for measurements with expected centimetre accuracy. We suggest you wait to obtain a **FIXED** solution.

FIXED: the GNSS is receiving differential corrections from the base, it is the final and best solution for corrections with maximum possible accuracy, usually within 2 cm.

HRMS and **VRMS** stand for horizontal and vertical root mean square. They are in meters or feet (depending on system settings) and can be used to have an idea of accuracy level. They are the horizontal and vertical distance within which 63% of positions are predicted to fall, to be exact. Twice RMS is the distance which 98% of positions are predicted to fall.

The **differential mode** is the format of differential messages (CMR, RTCM...). In Cube-a you always read **AUTO** because the decoding is made by GNSS receiver.

Differential correction age is the time (in seconds) taken by rover to receive corrections (e.g, 10 sec delay means that the base has sent a signal that rover has received after 10 seconds of submission). When RTK mode is running, the fix delay is low, so the result is better, generally the delay is less than 5 seconds.

PDOP: Position dilution of precision. The lower PDOP value, the better satellite distribution, which facilitates the achievement of **FIXED** solution.

HDOP: Dilution of horizontal precision.

VDOP: Dilution of vertical precision.

TDOP: Time dilution of precision.

GDOP: Geometric dilution of precision.

DOP Value	Rating	Description
1	Ideal	Highest possible confidence level corresponding to the highest possible precision.
1-2	Excellent	Measurements can be considered accurate enough to fulfill all civil/engineering/cadastral applications.
2-5	Good	Minimum appropriate for calculating usable but not so accurate point positions.
5-10	Moderate	The positional accuracy is not good enough for any civil applications. If possible, move to get a more open view of the sky.
10-20	Fair	Low confidence level. Positional measurements should be discarded, unless the position is used to get only some rough estimate of the point location.
>20	Poor	Measurements are inaccurate and they should be discarded.

The *Base* tab is shown in the following figure. It contains information about the base to which the rover is connected. Click *Store Base Coordinates* to save base point in the point library.

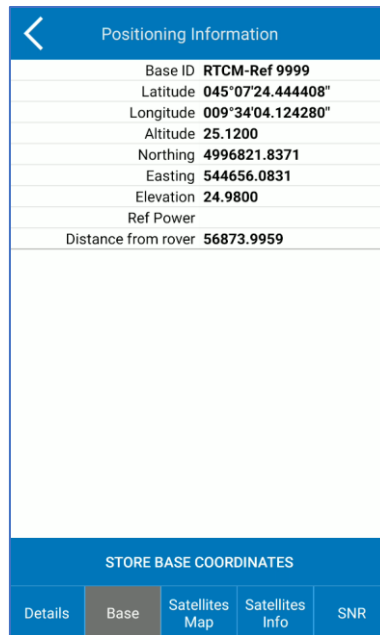

The *Satellites Map* tab is shown in the following figure. It contains the skyplot, so the position of satellites with respect to the GNSS receiver that is the center of the skyplot.

Legend: GPS-blue (GPS); BD-light green (BEIDOU); GLN-red (GLONASS); GAL-pink (GALILEO); SBAS-dark green (SBAS); ATL-yellow (ATLAS); IRN-purple (IRNSS); QZSS-brown (QZSS).

Seen satellites are colored in grey. Tracked satellites are fully colored with the respective color.

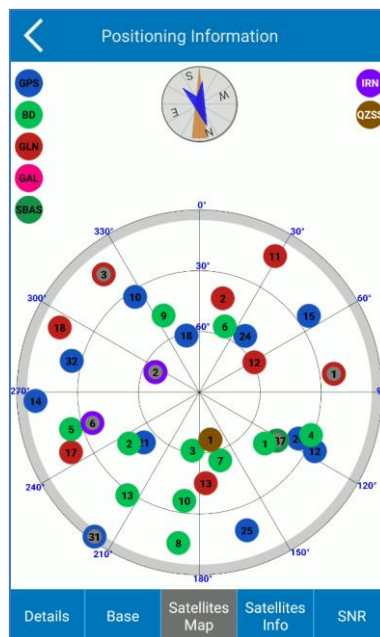

The *Satellites Info* tab and the *SNR* tab are shown in the following figures. They contain the name of the satellites, the L1, L2, L5 frequencies, the azimuth and the elevation angle, and the signal to noise ratio.

Positioning Information			
Satellite Number	L5/B3	Azimuth	Elevation Angle
G10	N/A	326.0	33.0
G12	N/A	117.0	26.0
G14	N/A	267.0	9.0
G15	N/A	55.0	24.0
G18	N/A	347.0	61.0
G20	N/A	115.0	36.0
G21	N/A	228.0	53.0
G24	N/A	39.0	54.0
G25	N/A	161.0	18.0
G31	N/A	216.0	2.0
G32	N/A	284.0	25.0
S129	N/A	122.0	45.0
S137	N/A	122.0	45.0
R1	N/A	82.0	23.0
R2	N/A	14.0	42.0
R3	N/A	321.0	15.0
R11	N/A	29.0	13.0

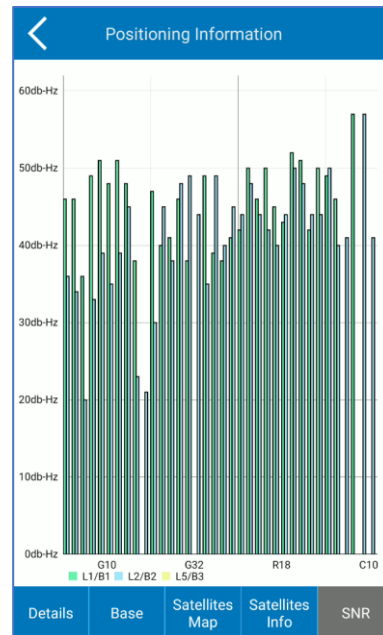

4.2 Datalink Status

The *Datalink Status* page contains the datalink details, depending on working mode (see [4.4 Working Mode](#)) and datalink type (see [4.5 Datalink Settings](#)).

4.3 Communication

In the *Communication* page, you can establish the connection between the instrument and the controller. First, select the device type from the dropdown menu. Select:

Stonex GNSS for all the latest generation Stonex GNSS receivers and the old Stonex S8 receivers.

Generic NMEA to connect a non-Stonex GNSS receiver.

Internal GPS to use the GPS inside the controller.

The remaining types according to the receiver model.

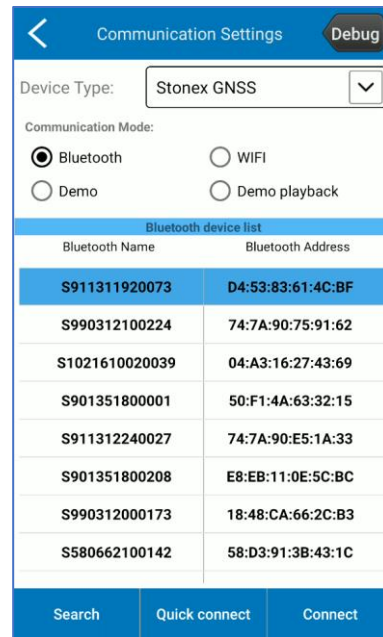
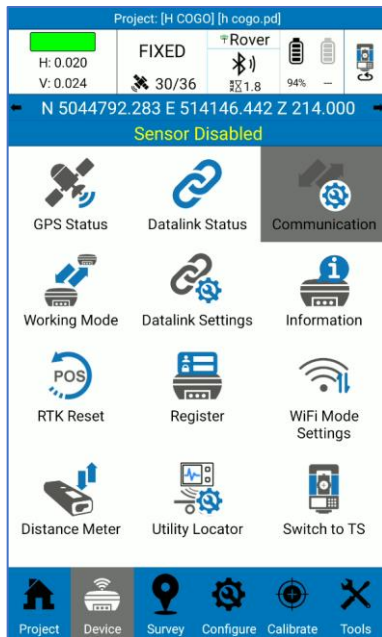

Secondly, set the mode of communication between Bluetooth and Wi-Fi. Click *Search* to search for nearby devices, select the device; you can recognize your device from serial number that will appear in the Bluetooth Name column. Finally, click *Connect* to establish the connection.

The command at the top “Debug” (active with each mode of communication) allows you to consult the outputs of the GNSS receiver; this data can also be recorded by checking the box Record data. By clicking on *Information output*, you can see the list of possible commands to send to the GNSS receiver to read its output (the box only show answers to commands works as a filter, you will see the outputs related only to the command sent).

At the bottom, the command Start starts receiving data; the command Send Data sends the command in the top window to the GNSS receiver (the window is editable); the command Clear cleans the data received window.

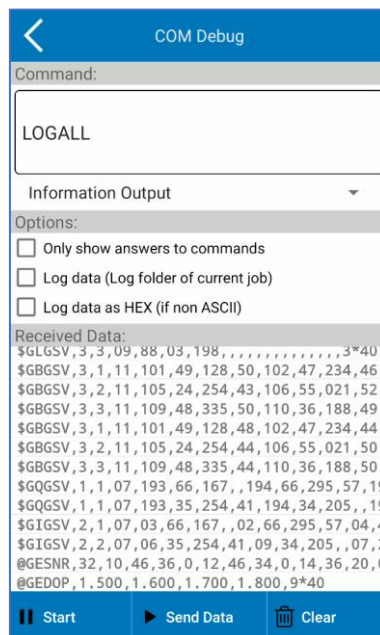

Demo mode

This option in Communication Mode section simulates the connection to a receiver, a useful function to show the functions of the program without having a GNSS receiver connected. The location of the "fake" GNSS can be set through geographic coordinates, it can be read from a point in memory or set with the target by clicking on the map and then on *Apply*; by pressing connect the simulation begins. The GNSS will simulate a motion, above the map you can set the static mode.

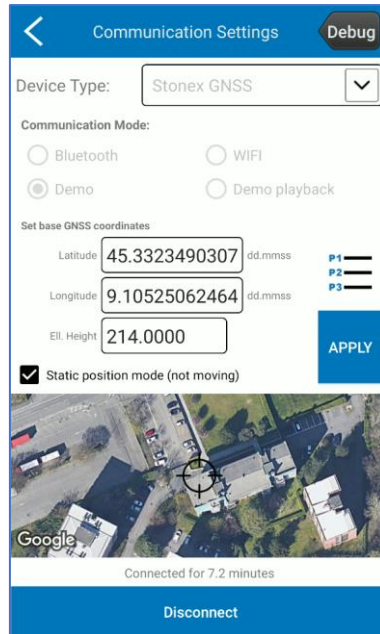

Demo playback

Plays a NMEA stream read from files as if it comes from a real GNSS device.

4.4 Working Mode

The *Working Mode* page allows you to configure the receiver as rover or base for RTK survey or for static survey. You can even set NMEA messages and launch configurations saved previously.

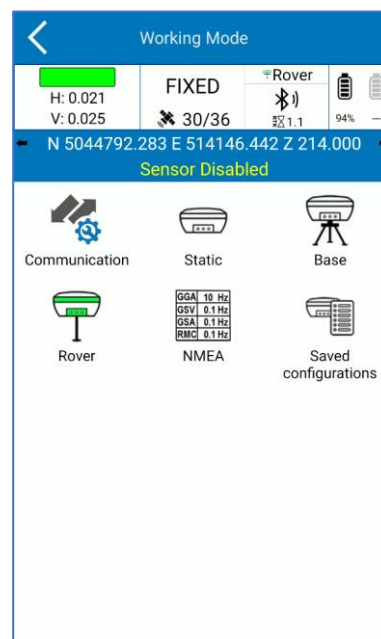
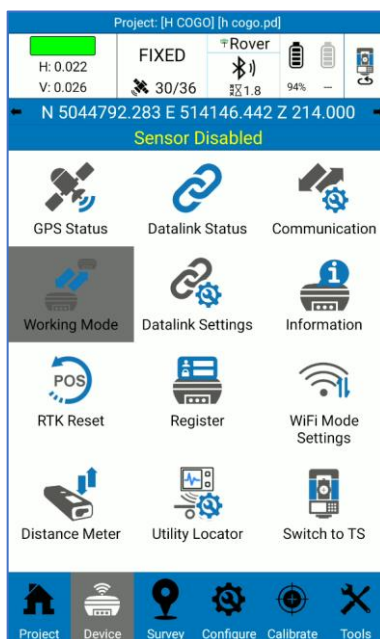

Saved Configurations

If you save the static, base, or rover configurations, you can find all of these in *Saved configurations* page. Here you can simply select the configuration and click OK to launch the configuration. Click *details* to see details of the selected configuration; click *delete* to delete the selected configuration.

4.4.1 Static

The Static mode settings window is shown in the following figure.

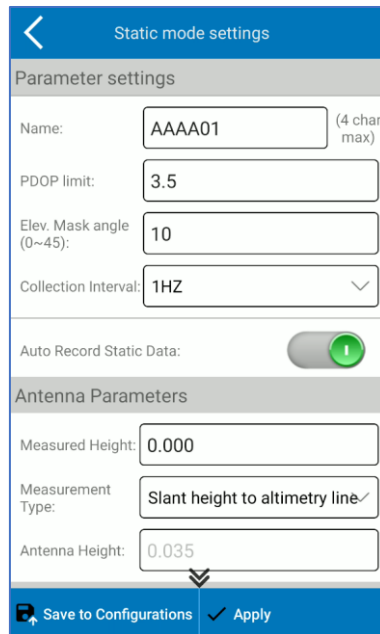

Parameter settings

Name: The name of the points in static is limited to 4 characters.

PDOP limit: the maximum PDOP accepted. PDOP meaning at [4.1GNSS Status](#).

Elevation Mask angle: the cut off angle starting from horizon. The receiver will not consider satellites in this angle.

Collection Interval: 1 Hz indicates the acquisition of one data per second, 5 HZ indicates the acquisition of five data per second, 5 s indicates that the receiver collects data every five seconds, and so on.

Auto Record Static Data: if enabled, the receiver starts recording automatically when it is turned on, otherwise you need to manually start raw data recording.

Antenna Parameters

You can enter the measured height and set how the measurement is done. The antenna height value used in the survey will be calculated automatically by the program, depending on GNSS phase center position, and visible in the text box Antenna Height.

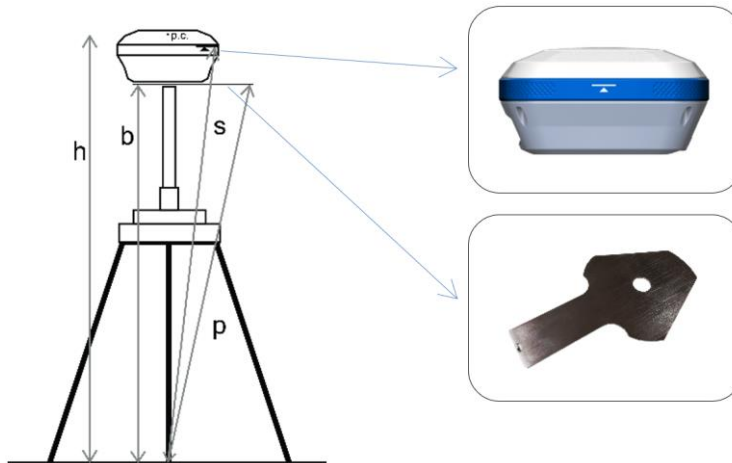

Measurement Type:

- Vertical height -> insert **b**
- Height to phase center -> insert **h**
- Slant height to altimetry line ->insert **s**
- Slant height to altimetry plate -> insert **p**

Satellite Systems

This section includes seven systems: GPS, GLONASS, BEIDOU, GALILEO, NAVIC/IRNSS, QZSS and SBAS. Depending on your work needs, you can choose whether to receive the signal from a constellation or not.

The Satellite Based Augmentation System (SBAS) is a large-scale differential improvement system (improvement system based on the quality of satellite signal). Navigation satellites are surveyed by many widely distributed different stations and the acquired raw data is sent to a computing center. Then from the calculation center, correction information is sent to geostationary satellites of the covered area, and finally, geostationary satellites send corrections to users, helping to improve positioning accuracy.

You can save the configuration by clicking on the corresponding button; this allows you to launch the same configuration later (or in a new project) without having to reinsert all parameters.

Click *Apply* to start the receiver to static working mode.

4.4.2 Base

There are two start up mode for base configuration.

Use Current Coordinates

The program takes the current WGS-84 coordinates from the GNSS and sets them as base coordinates. They depend on the GNSS receiver current position and accuracy.

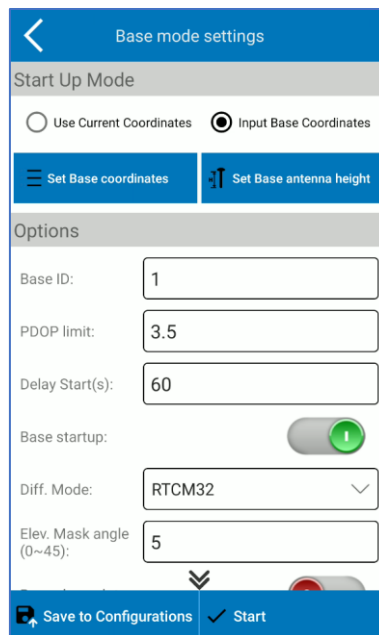

Input Base Coordinates

You can manually set base coordinates. This way you must insert even the antenna height.

Click *Set Base coordinates* to set them and the following page opens.

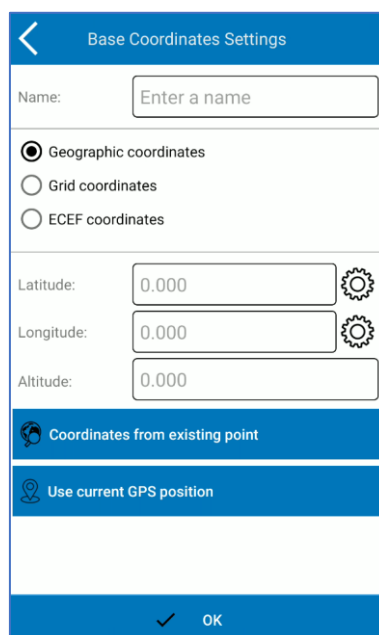

The coordinates sent by program to base are always geographic, but you insert in different formats.

If you select “Geographic coordinates”, then the coordinates will be sent as well as you insert them, so the altitude is the ellipsoidal height. Click on gear icon to change angle format.

If you select “Grid coordinates”, then the coordinates you insert will be converted in geographic coordinates by using the coordinate system set in Cube-a, and the geoid also if it’s enabled.

If you select “ECEF coordinates”, then the coordinates you insert will be converted in geographic coordinates on WGS-84 ellipsoid (the coordinates system and the geoid set are not considered).

And therefore, if you know the local height above sea level then you must select Grid option and previously set the Geoid (and the right coordinate system) in Cube-a.

You can manually insert the coordinates in the format chosen or take from existing point (e.g., when you previously saved the base point in RTK mode or when you imported the point in the library).

Click OK to confirm the base coordinates.

Click *Set Base antenna height* to set base height and the following page opens.

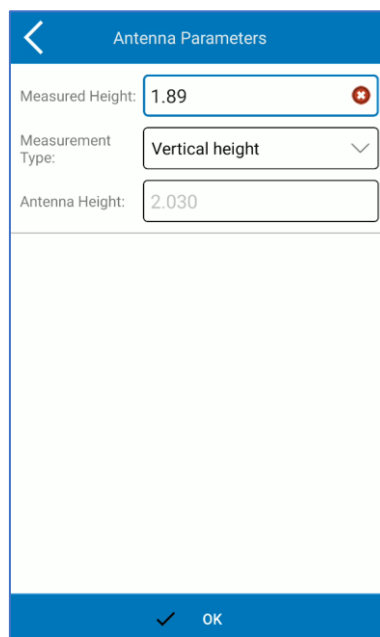

You can enter the measured height and set how the measurement is done. The antenna height value used in the survey will be calculated automatically by the program, depending on GNSS phase centre position, and visible in the text box Antenna Height.

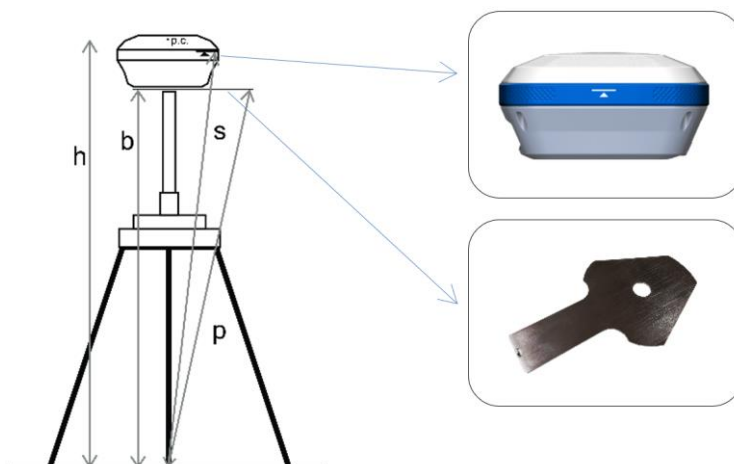

Measurement Type:

- Vertical height -> insert **b**
- Height to phase center -> insert **h**
- Slant height to altimetry line ->insert **s**
- Slant height to altimetry plate -> insert **p**

Options

In this section you can indicate the Base ID, the PDOP limit value (PDOP meaning at [4.1GNSS Status](#)), the base start delay, the differential data format, the elevation mask angle (satellites in this angle starting from horizon will not be considered) and the raw data recording.

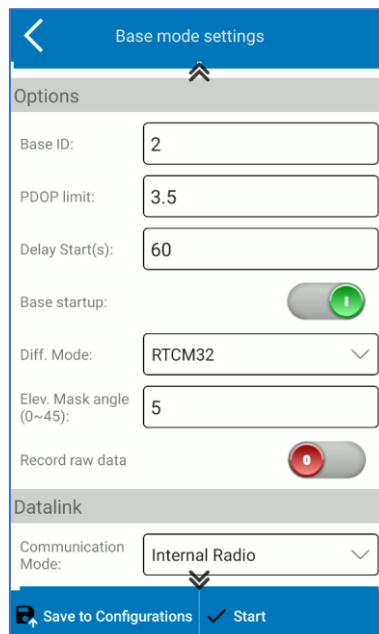

Datalink

Select communication mode from the dropdown menu. See [4.5Datalink Settings](#) for details on each communication mode.

Satellite Systems

Satellite systems section includes seven systems: GPS, GLONASS, BEIDOU, GALILEO, NAVIC/IRNSS, QZSS and SBAS. Depending on your work needs, you can choose whether to use the signal from a constellation or not.

The Satellite Based Augmentation System (SBAS) is a large-scale differential improvement system (improvement system based on the quality of satellite signal). Navigation satellites are surveyed by many widely distributed different stations and the acquired raw data is sent to a computing center. Then from the calculation center, correction information is sent to geostationary satellites of the covered area, and finally, geostationary satellites send corrections to users, helping to improve positioning accuracy.

You can save the configuration by clicking on the corresponding button; this allows you to launch the same configuration later (or in a new project) without having to reinsert all parameters.

Click *Start* to start the receiver to base working mode.

4.4.3 Rover

Rover mode settings page is shown in the following figure.

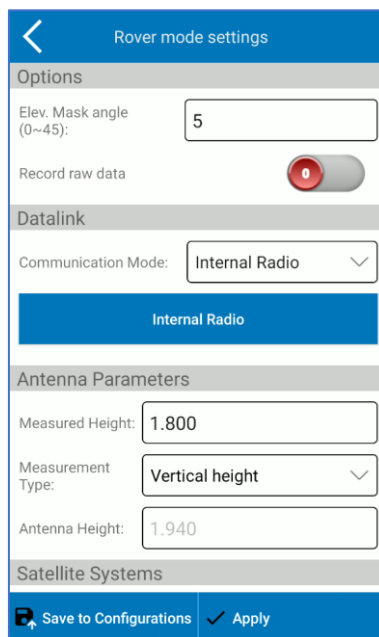

Options

Elevation Mask angle: the cut off angle starting from horizon (satellites in this angle will not be considered).

Record raw data: you can enable the GNSS raw data recording if you need.

- Collection Interval: 1 Hz indicates the acquisition of one data per second, 5 HZ indicates the acquisition of five data per second, 5 s indicates that the receiver collects data every five seconds, and so on.
- The name of the raw data file is limited to 4 characters.

Datalink

Select communication mode from the dropdown menu. See [4.5 Datalink Settings](#) for details on each communication mode.

When you configure the Rover, you can find the “a-RTK” option in the Datalink section.

The a-RTK function does not mean ATLAS, even if also a-RTK makes use of ATLAS satellites. If you enable a-RTK, the receiver continues generating RTK positions up to 20 min from loss of the RTK correction source. This function does not require additional costs, and the points saved with a-RTK are in the same coordinate reference system defined by the user, so the same of the other points saved in RTK.

a-RTK stays in centimetre precision for 20 minutes after the GNSS has lost the correction signal, but the performance decreases as time increases; this is the reason why you can choose the time for using the function. The GNSS receiver needs at least 1 minute of RTK correction to start the a-RTK feature. The countdown

restarts when the GNSS receiver requires the correction signal, so you can use the a-rtk feature every time you want during the survey.

Antenna parameters

You can enter the measured height and set how the measurement is done. The antenna height value used in the survey will be calculated automatically by the program, depending on GNSS phase center position, and visible in the text box Antenna Height.

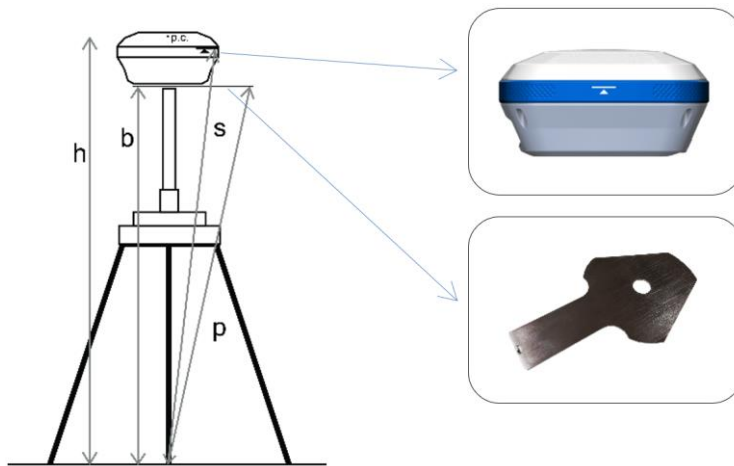

Measurement Type:

- Vertical height -> insert **b**
- Height to phase center -> insert **h**
- Slant height to altimetry line ->insert **s**
- Slant height to altimetry plate -> insert **p**

Satellite Systems

This section includes seven systems: GPS, GLONASS, BEIDOU, GALILEO, NAVIC/IRNSS, QZSS and SBAS. Depending on your work needs, you can choose whether to receive the signal from a constellation or not.

The Satellite Based Augmentation System (SBAS) is a large-scale differential improvement system (improvement system based on the quality of satellite signal). Navigation satellites are surveyed by many widely distributed different stations and the acquired raw data is sent to a computing center. Then from the calculation center, correction information is sent to geostationary satellites of the covered area, and finally, geostationary satellites send corrections to users, helping to improve positioning accuracy.

You can save the configuration by clicking on the corresponding button; this allows you to launch the same configuration later (or in a new project) without having to reinsert all parameters.

Click *Apply* to start the receiver to rover working mode.

4.5 Datalink Settings

Different data transmission modes are available, and they depend on working mode (base or rover) and on GNSS you are connected. In the following paragraphs there is the description of all communication modes that you can select in datalink section when you configure the base or rover.

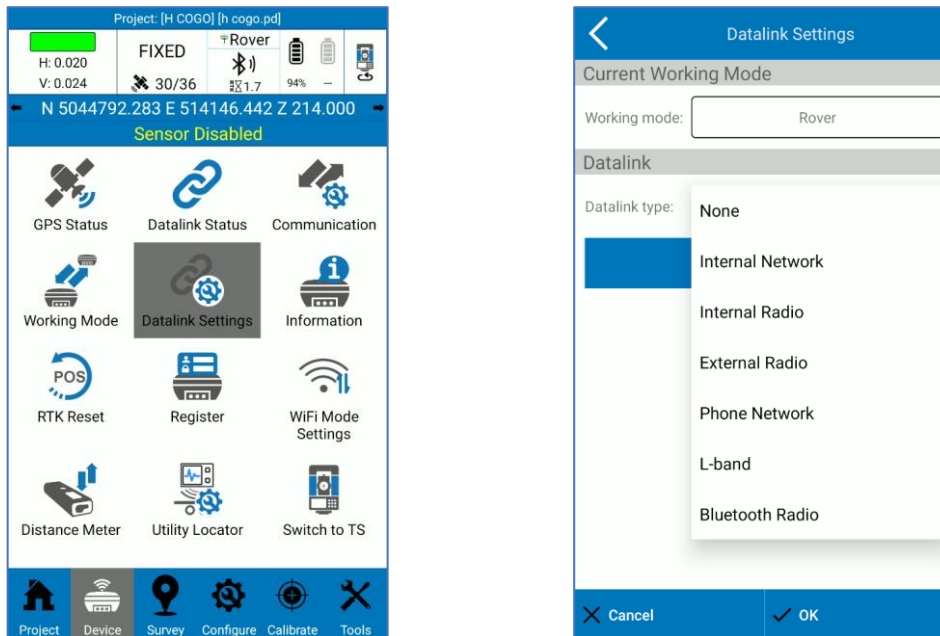

None

No differential data is sent or received. You will work with SINGLE solution.

Internal Network

See [4.5.1 Internal Network](#)

Internal Radio

See [4.5.2 Internal Radio](#)

External Radio

You can connect an external radio to base and/ or rover if they don't have it or to increase the range of data transmission. The external radio settings page is the same for base and rover. You need to set only the Baud Rate. You must configure the radio (protocol, channel...) from radio, or radio application.

Phone Network

See [4.5.3 Phone Network](#)

L-band

Differential data is receiving by ATLAS satellite trough L-band signal. ATLAS is an exclusive PPP technology that provides real-time centimeter-level positions; once the corrections are calculated, they are delivered directly to the end user via geostationary satellite. ATLAS positions are referenced to ITRF08 current epoch.

Bluetooth Radio

It's so close to external radio. This way, the external radio is connected through Bluetooth, so when you select this communication mode, the first (and only) step is to establish the Bluetooth connection between tablet and external radio. You must configure the radio (protocol, channel...) from radio.

Dual

Simultaneous sending of data to a remote station via the internal network and via external radio.

4.5.1 Internal Network

Differential data is transmitted through the network, so you must insert a SIM card with internet connection available inside the receiver. In the following figures is shown the internal network settings for base and rover.

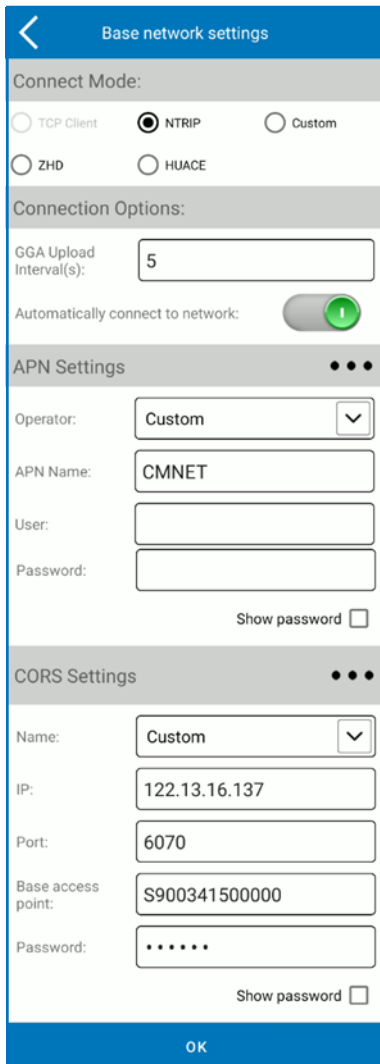

Base network settings

Connect Mode:
 TCP Client NTRIP Custom
 ZHD HUACE

Connection Options:
 GGA Upload Interval(s):
 Automatically connect to network:

APN Settings ⋮
 Operator:
 APN Name:
 User:
 Password:
 Show password

CORS Settings ⋮
 Name:
 IP:
 Port:
 Base access point:
 Password:
 Show password

OK

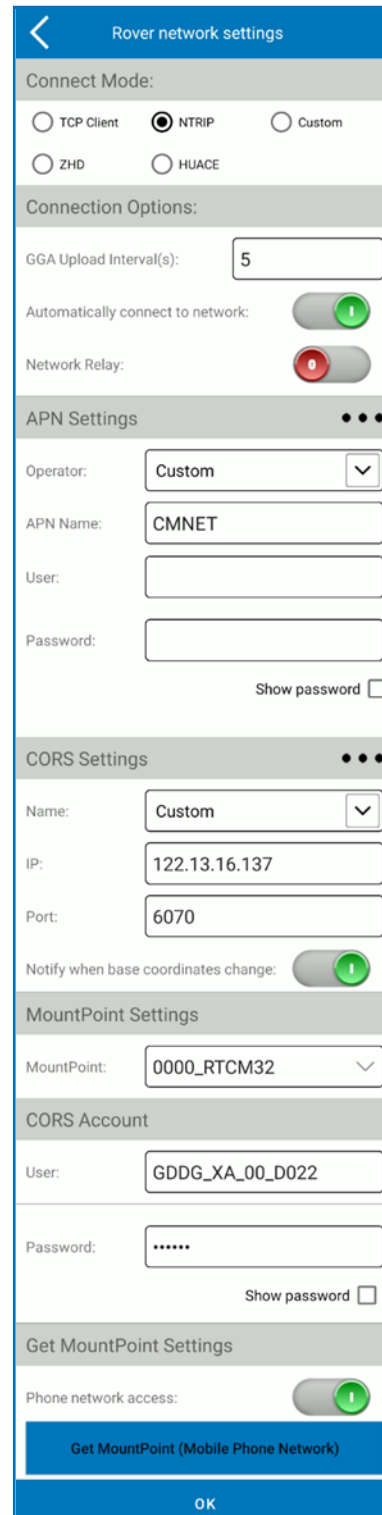

Rover network settings

Connect Mode:
 TCP Client NTRIP Custom
 ZHD HUACE

Connection Options:
 GGA Upload Interval(s):
 Automatically connect to network:
 Network Relay:

APN Settings ⋮
 Operator:
 APN Name:
 User:
 Password:
 Show password

CORS Settings ⋮
 Name:
 IP:
 Port:
 Notify when base coordinates change:

MountPoint Settings
 MountPoint:

CORS Account
 User:
 Password:
 Show password

Get MountPoint Settings
 Phone network access:
 Get MountPoint (Mobile Phone Network)

OK

Connect Mode

TCP: standard transmission control protocol, specific for network transmissions.

NTRIP: standard protocol used to transmit differential data over the CORS network.

ZHD: differential transmission mode of the HI-TARGET network. HUACE: differential transmission mode of the CHC network. It is also possible to define a user-defined transmission protocol.

Connection options

GGA Upload Interval: value of the GGA message sending interval (by default 5 sec).

Automatically connect to network: the connection starts or re-starts automatically if enabled.

Network Relay: data received via the network are relayed via internal radio to make them available for other rovers.

APN Settings

You can search for a telephone operator by opening dropdown menu or add a new one by clicking on the search button (icon with three dots) or use a custom operator by inserting parameters in the dedicated fields. The operator depends on the SIM card you are using.

CORS Settings

Base CORS settings: set the Caster IP address, it can be alphanumeric; set the Caster port; the base access point is fixed to the receiver serial number; set the Caster Password (it may not be requested).

Rover CORS settings: you can search for a CORS by opening dropdown menu or add a new one by clicking on the search button (icon with three dots) or use a custom CORS by inserting parameters in the dedicated fields.

You can enable a warning message each time you change base coordinates.

CORS Account

Set the user and password to access the CORS.

Get MountPoint Settings

Get the entry points (mountpoint), you can use the receiver's network or the device's telephone network.

MountPoint Settings

Select the mountpoint from dropdown menu once you have downloaded the list of mountpoint.

4.5.2 Internal Radio

Differential data is transmitted via GNSS internal radio. In the following figures is shown the internal network settings for base and rover.

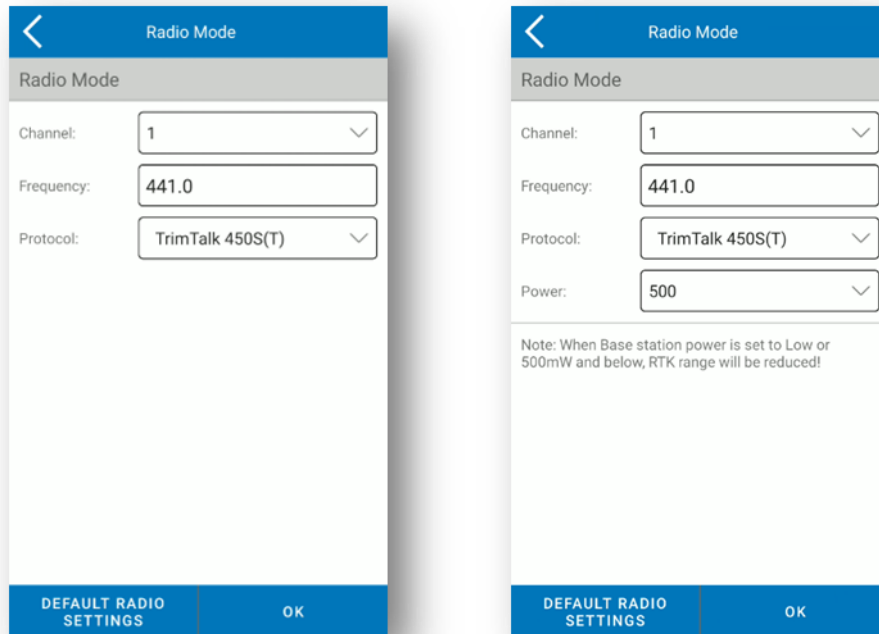

The list of available protocols depends on the connected GNSS receiver.

There are 8 channels, for each channel there is a preset frequency but if you choose channel 8 you can change the frequency. Click *Default Radio Settings* below to change the frequency of the channels.

The frequency and protocol of Base and Rover must be the same. In Basic mode, radio power affects the signal transmission distance. If the power is low, the energy consumption is also low, but the signal transmission distance is reduced; if instead the power is high, the energy consumption is high, but the signal transmission distance is extended.

4.5.3 Phone Network

Differential data is receiving through the controller network, so you must insert a SIM card with internet connection available inside the controller connected to GNSS or connect the controller to hotspot. This communication mode is only for rover.

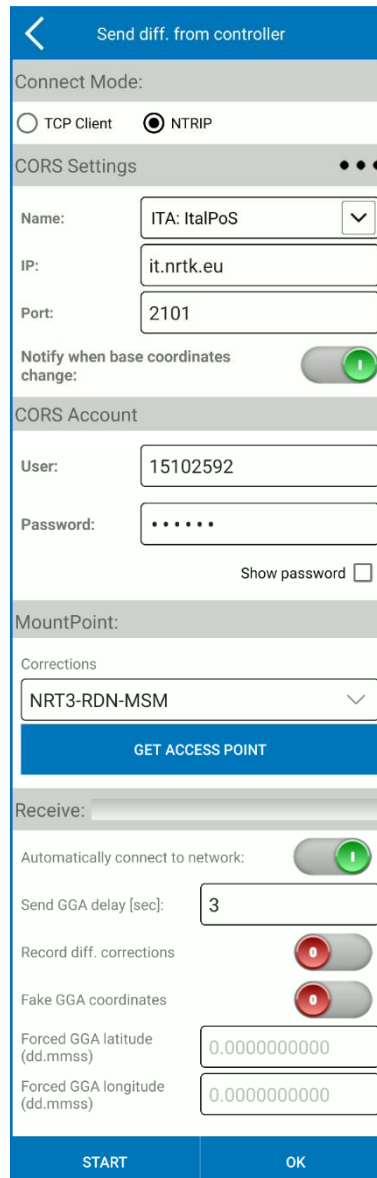

Connect Mode

TCP: standard transmission control protocol, specific for network transmissions.

NTRIP: standard protocol used to transmit differential data over the CORS network.

CORS Settings

Rover CORS settings: you can search for a CORS by opening dropdown menu or add a new one by clicking on the search button (icon with three dots) or use a custom CORS by inserting parameters in the dedicated fields.

You can enable a warning message each time you change base coordinates.

CORS Account

Set the user and password to access the CORS

MountPoint

Click Get Access Point to download the list of mountpoints.

Select the mountpoint from dropdown menu.

Automatically connect to network: the connection starts or re-starts automatically if enabled.

Send GGA delay: interval (in seconds) to send position to NTRIP caster, to obtain the right corrections for that position.

Record diff. corrections: only for debug, to record all corrections received (and to send them to us) for test.

Fake GGA coordinates: send fake position to caster, only for test.

Forced GGA: set fake position to force it if the previous option is enabled.

Click *Start* to start receiving differential corrections.

4.6 Information

This page contains all detailed hardware and firmware information about the GNSS receiver connected to the device.



4.7 RTK Reset

This function forces the GNSS board re-initialization. This will result in a complete recalculation of the location from new satellite signals.

4.8 Register

You can see the expiration date of the GNSS receiver's user license (that is not the Cube-a license). You can also insert a new GNSS receiver code (temporary or permanent): the GNSS must be connected to Cube-a.

4.9 WiFi Mode Settings

This function allows you to set the Wi-Fi connection of the GNSS receiver.

MASTER: the GNSS acting as hotspot, so other devices can connect to it (e.g., Cube-a can connect to the GNSS by WiFi instead of by Bluetooth).

CLIENT: the GNSS is connected as client to a WiFi network (WiFi hotspot). The password is needed to access the selected WiFi unless it is not protected. When the GNSS is in CLIENT mode, its WiFi is not visible. To restore the MASTER mode, connect to the GNSS using Bluetooth.

4.10 Distance Meter

You can even connect a distance meter to Cube-a via bluetooth. The supported brands are Stonex and Leica. A screen will open where you can search and connect a Disto.

With the connected instrument it will be possible to measure directly from the Cube-a; the "Measure" command below, which will start the measurement, in this case three measurements have been made. The "Clean up" button will be useful for deleting data and starting from scratch. The Disto command is available in all Cube-a functions that require measurement (but the command will only be visible if the distance meter has previously been connected).

4.11 Utility Locator

You can connect the controller and use Cube-a with RD1800 Pipe Locator. This feature is available with the GIS module only. The page "Utility Locator" consists only in Bluetooth connection between the controller and the detector.

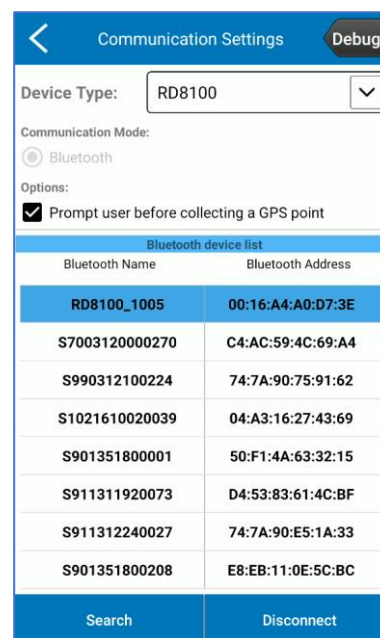
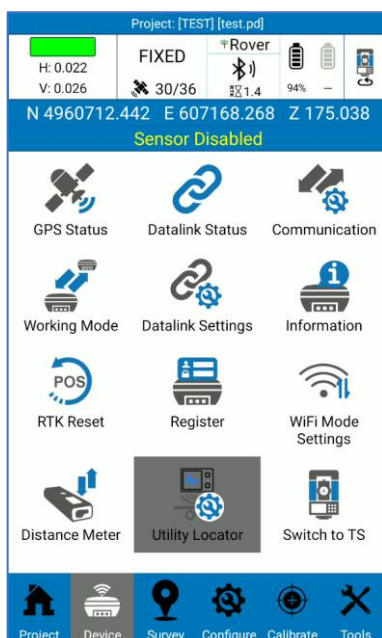

The first time you try to establish the connection, the pairing is required, and the password is 1234. Then, select the device and click *Connect*. See the detector user manual for more details on Bluetooth activation and locator settings.

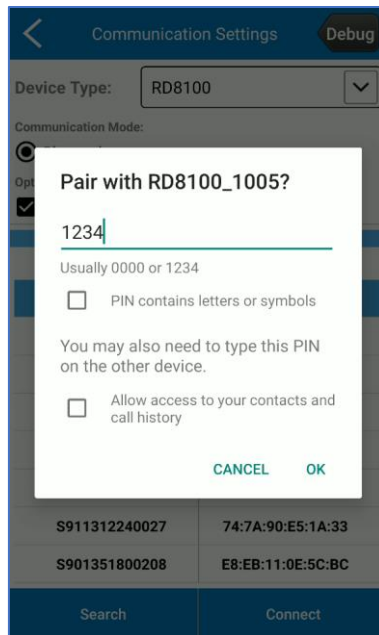

Once the connection is done, when you press the measure button  on the instrument to take measurement of the found pipes, the following message automatically appears in Cube-a. This way, you can move the GNSS on the point where the locator is to collect GPS position.

NB. If you disable the option “Prompt user before collecting GPS point” in Bluetooth connection page, then the following alert does not appear and the GPS position is taken as soon as you press the measure button on the detector.

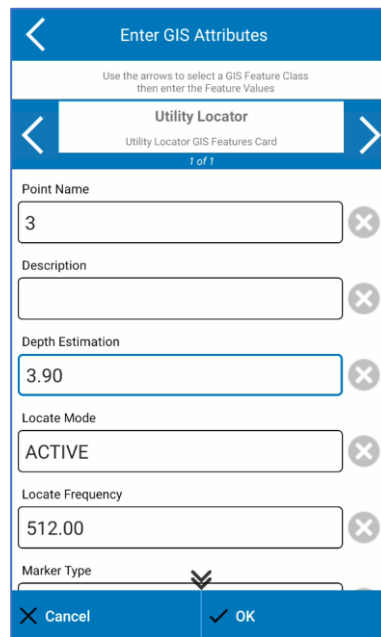
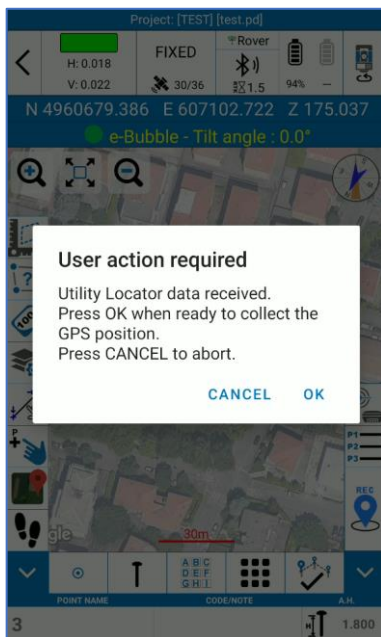

Remind to enable the GIS option and select Utility Locator GIS group of attributes to automatically save the detector measures as GIS attributes when you save the GPS point. Cube-a automatically take information from detector and insert them in the related GIS field, as in the figure above.

Project Details

Project Name: test

Enable GIS:

Operator:

Device:

Notes:

Coordinate systems parameters type: Local parameters

Warning: do not select the RTCM1021~1027 parameters option unless you are sure that the CORS sends them out.

Ground to grid s.f. (TS): 1.00000

Date Created: 2022-03-02 09:42:59

Symbol Library: Standard

OK

Activate GIS Feature Set Repository

Feature sets repository

UTILITY-LOCATOR

Edit Add Clone Delete

Repository description

Utility Locator Sample Feature Set

Repository contents

Utility Locator
Utility Locator GIS Features Card
 Compatible geometries
 • Point

Cancel OK

5. Device – TS Module

The Device menu contains all the functions concerning the communication and configuration of the GNSS receiver and the Total Station, in fact it looks different depending on the GPS or TS module, as shown in the following figures.

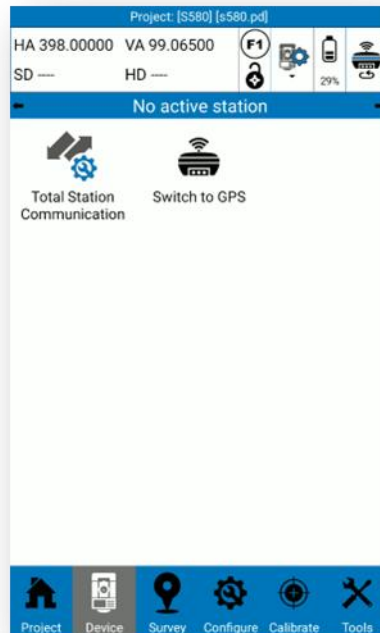

5.1 Total Station Communication

There are currently five supported total stations: Stonex R15, Stonex R25, Stonex R20, Stonex R35, Stonex R80. The demo mode works only if you select Stonex R80.

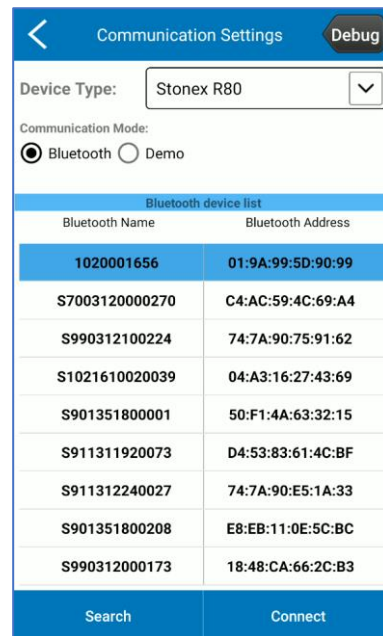
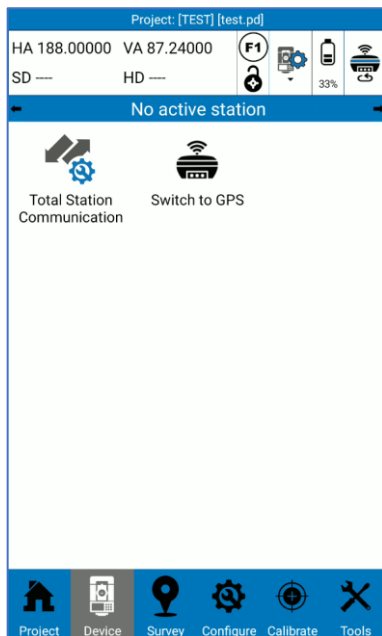

6. Survey

The *Survey* menu contains the survey area, the stakeout functions, and the CAD environment. In the total station mode, there is also the gridded scan function.

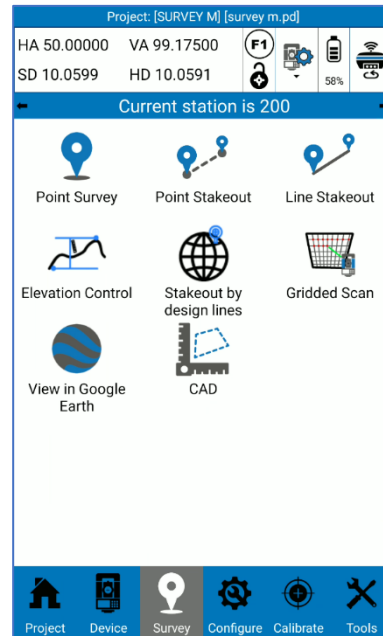

Click *Point Survey* to access the survey area. Here you can save points, see them on the background Google maps or DXF, draw while you are saving points, select points and CAD entities directly typing on them, change layer, perform geometric calculations and many other operations described in following.

The page looks different depending on module (GPS or TS). The common functions will be described in the following paragraph; see paragraphs [6.1.1 GPS Survey](#), [6.1.2 GIS Survey](#), [6.1.3 TS Survey](#), for specific functions in each mode.

6.1 Point Survey

Below there is the description of the icons in survey area common for GPS and TS mode.

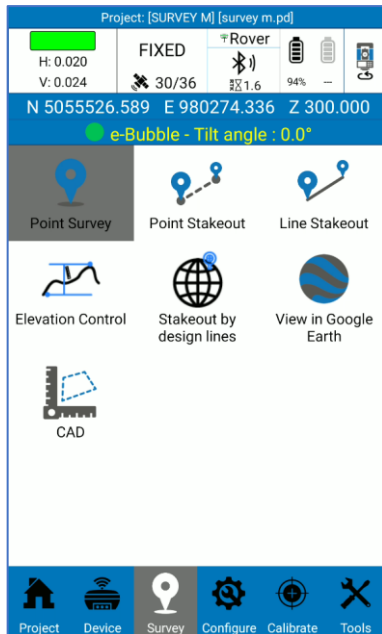

Zoom in



Zoom all



Zoom out



Compass (same as the compass device on which Cube-a is installed)



Click to access to the CAD environment (see [6.9 CAD](#))



Calculate distances and area between points on the map. Click on the icon to enable it then it will turn yellow, and you can tap on the map to define the points. The distance between two segments is shown in green in the center of the segment, the progressive distances are shown in green on the points, and the area is in red in the center of the geometry.



Click to make visible or not the point labels. Hold down to access to [7.1 Display Settings](#).



Click to access to the [7.2 Layers](#).



Select line. Click on the icon to enable it then it will turn yellow, and you can click directly on the line in graphic to access the line staking out.



Select point. Click on the icon to enable it then it will turn yellow, and you can click directly on the point in graphic to access the point staking out.



Background map. Click to enable or change the map type. Hold down to access to the [7.3 Background Map](#) page.



map disabled



road map



satellite map



Follow me function is enable: the map is always centered based on the position of the receiver. Click to disable then a red cross will appear.



Hide the side column.



Save only points. Click on the icon to choose the entity to draw while saving points or return to point capture only (see [7.4 Draw during the survey](#)).



Click to change the current point type (see [7.5 Point type](#)).



Save the point by clicking on the respective code. Hold down to quickly access to the code library ([3.9 Feature Codes](#)).



Click to access to the [7.6 Survey Tools](#).



Click to end the entity you are drawing (see [7.4 Draw during the survey](#)).



Set the fake GNSS position, available only in DEMO mode (see [4.3 Communication](#)).



Click to open the [3.4 Point Library](#).

The bottom bar has the following fields:

POINT NAME	CODE/NOTE	A.H.
1	ADR	 2.000

- The name of the next point. Click to change the name.
- Code for next point. Click to change the code.
- Antenna height

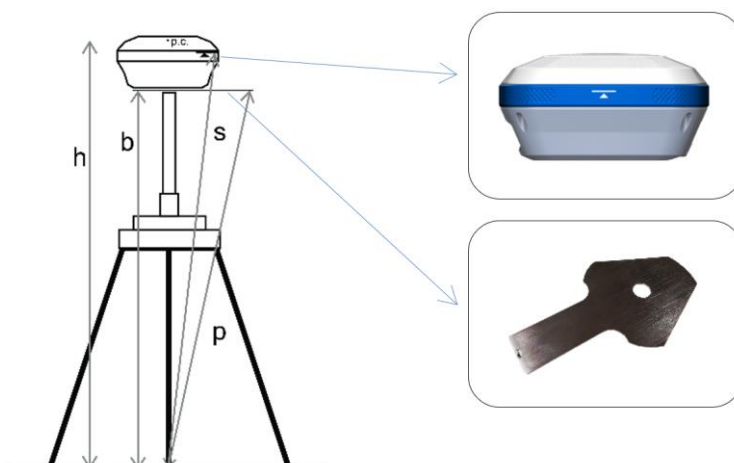

In GNSS mode, you can choose from the following options:

- *Vertical height*: insert **b**

- Height to phase center: insert **h**
- Slant height to altimetry line: insert **s**
- Slant height to altimetry plate: insert **p**

In Total Station mode, the values refer to the height of the pole.

NOTE: Enter the height of the pole only if you have already considered the vertical offset of the prism in the prism setting (see [2.2.1 TS Control Panel](#)).

6.1.1 GPS Survey

In GPS mode, the survey area looks like the following figure.



The only icon more than those described in the previous paragraph is the following



Record GPS point

6.1.2 GIS Survey

If the GIS option is enabled for the current project, the *Enter GIS Attributes* window appears after saving a point or CAD entity. Here you can choose the attribute class by clicking on the right or left arrow and enter the GIS attributes accordingly. Click *Cancel* to clear the inserted attributes or click *OK* to confirm.

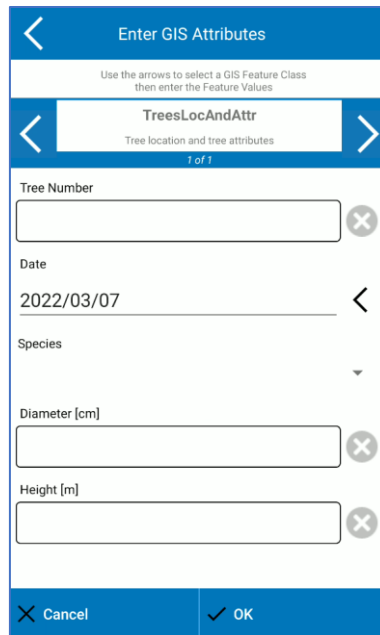

The screenshot shows a mobile application interface for entering GIS attributes. The title bar is blue with a back arrow and the text 'Enter GIS Attributes'. Below the title bar, there is a subtitle 'TreesLocAndAttr' and a note 'Tree location and tree attributes'. The form contains several input fields: 'Tree Number' (text input), 'Date' (calendar icon, showing 2022/03/07), 'Species' (dropdown menu), 'Diameter [cm]' (text input), and 'Height [m]' (text input). Each text input field has a small 'X' icon to its right. At the bottom, there are two buttons: 'Cancel' with an 'X' icon and 'OK' with a checkmark icon.

6.1.3 TS Survey

In Total Station mode, the survey area looks like the following figure.

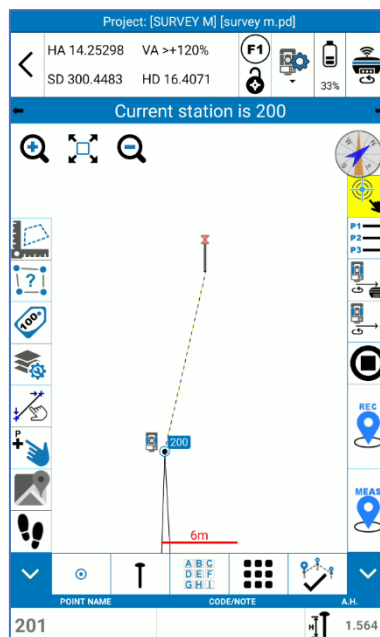

The *MEAS* and *REC* icons are red when the station has not yet been declared. Cube-a will not allow you to survey points as long as the keys remain red, but pressing on one of them, you will have the following message that leads directly to the station definition page. Click OK to declare the station (see [10.1 Station on point](#) and [10.2 Resection/Free Station](#)).

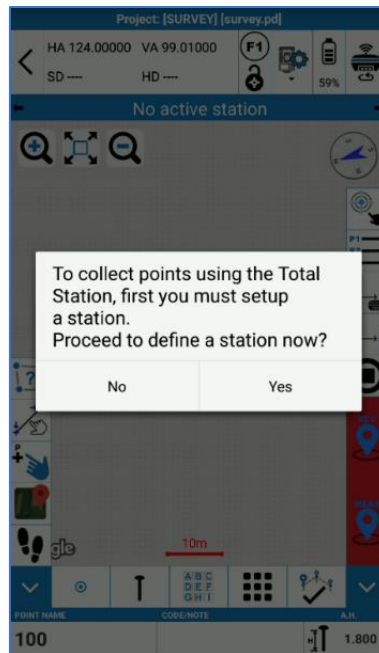

In the survey area, in addition to the icons described in [6.1 Point Survey](#), in TS mode there are the following functions.



Measure



Save points if a measure has already been made, otherwise measure, and save the point.



Stop the measurement if you are in tracking mode or searching for the prism.



Rotate the telescope to a point. It can be used during measurement, after you have defined the station and its orientation.



Rotate the telescope to the GPS location. It can be used during surveying, after you have defined the station and its orientation, it is enabled if you have the Cube-a GPS module and if the antenna is in a fixed solution.

6.2 Point Stakeout

The point stakeout interface is shown in the following figure.

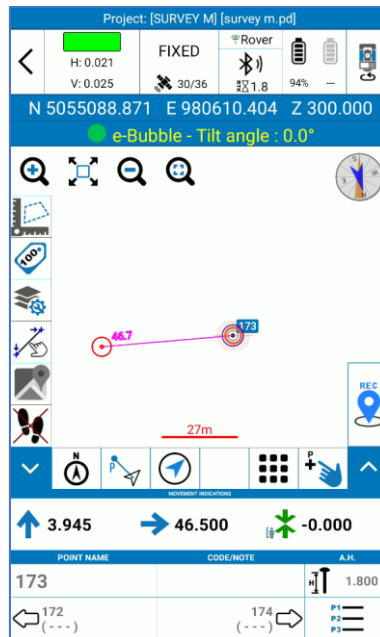

In addition to the functions that are in [6.1 Point Survey](#), there are also the following features.



Zoom in on your position and the point you want to stakeout.



Define the orientation. The indications to reach the point depends on this option.

North: rotate on yourself so that the North is in front of you.

South: rotate on yourself so that the South is in front of you.

Sun: rotate on yourself so that the Sun is in front of you.

Shadow: rotate on yourself so that the Sun is behind you.

Point: rotate on yourself so that the reference point is in front of you.

Line: rotate on yourself to have the same orientation of the defined alignment. To define the alignment points, use the point selection tool (blue pointing hand).

Station (2-man): choose this option if there are two people at least in the field (only in TS mode). One stays at the total station and gives instructions to the second one who is close to prism.

Station (1-man): choose this option if you are alone in the field. It must refer to the location of the station and move by supporting the prism. This mode is to be used if you are working with a motorized/robotic station.



Shows the current location on the map, by representing a red arrow. The picket point is highlighted with a red and blue circle, and a purple line, which connects current position and point, shows the distance.



Shows the direction in which you are moving through a blue arrow and the distance between the current position and the point to stake out. To return to the map view press the .

MOVEMENT INDICATIONS								
↓ 0.668	← 41.717	↑ 75.029						
POINT NAME	CODE/NOTE	A.H.						
t_10		2.000						
← 155 (---)		<table border="1"> <tr><td>P1</td><td>—</td></tr> <tr><td>P2</td><td>—</td></tr> <tr><td>P3</td><td>—</td></tr> </table>	P1	—	P2	—	P3	—
P1	—							
P2	—							
P3	—							

1. Move back or forward to the distance shown to find the point: once the point is found, satisfying the declared tolerance, the arrow will turn green .
2. Move left or right for the distance shown to find the point: once the point is found, satisfying the declared tolerance, the arrow will turn green .
3. Shows the elevation of the stake out point: the point can be above or below , suggesting stretch or carry-over: once the point is found, satisfying the declared tolerance, the arrow will turn green .
4. ID of the point you are Setting out.
5. Picket the previous point.
6. Picket the next point.
7. Access the points library to select another point to stakeout.

Click the icon highlighted in red to access the *Survey Tools*. In addition to the functions described in [7.6 Survey Tools](#) there are also the *Stake Point Settings*.

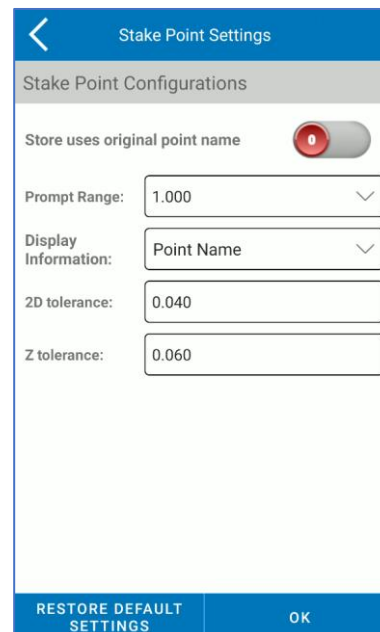
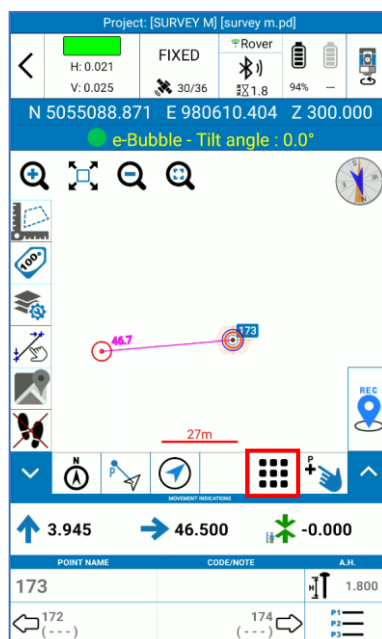

Prompt Range: three concentric circles can be displayed on the screen around the point (the center is the point to stake out). Define the maximum distance from the point for displaying circles.

Display Information: Select what information you want to see on screen.

2D tolerance: Insert staking out tolerance into floor plan.

Z tolerance: Insert the tolerance for stacking out in elevation.

6.3 Line Stakeout

The Line stakeout interface is shown in the following figure. The icons are the same described in the previous paragraph, see [6.2 Point Stakeout](#) for more details on available options. The line you are staking out is

highlighted in red. The current position is shown with a red circle (if you hold still) or arrow (if you move). The point you are staking out is shown with an orange circle. The pink value is the chainage with respect to the first point of the line that is 0.000.

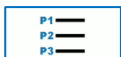
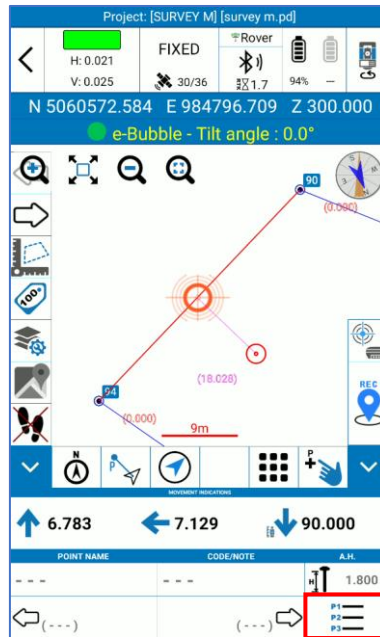

Click here to access the line library and select another line to stakeout.

If you want to stakeout a line from a DXF file, remind that, if you import the file as external drawing then the lines and entities of the DXF are not listed in the line library so they must be selected from the map in the Survey Area (see [6.1 Point Survey](#)).

6.3.1 Line Stakeout Settings

The page *Stakeout settings* shown below appears as soon as you select a line to stakeout.

Offset distance

Stakeout the line selected shifted by value you insert.

Setting out of intermediate points

Disabled: the indications are only for reach the line or the extensions of the line.

Enabled: the indications are for reach specific points on the line, on the extensions of the line or on the shifted line.

In the following example, setting out of intermediate points is enabled and the line has been divided in two (interval value) parts, so the indications are for reach specific points that are the first, the middle and the end point of the line.

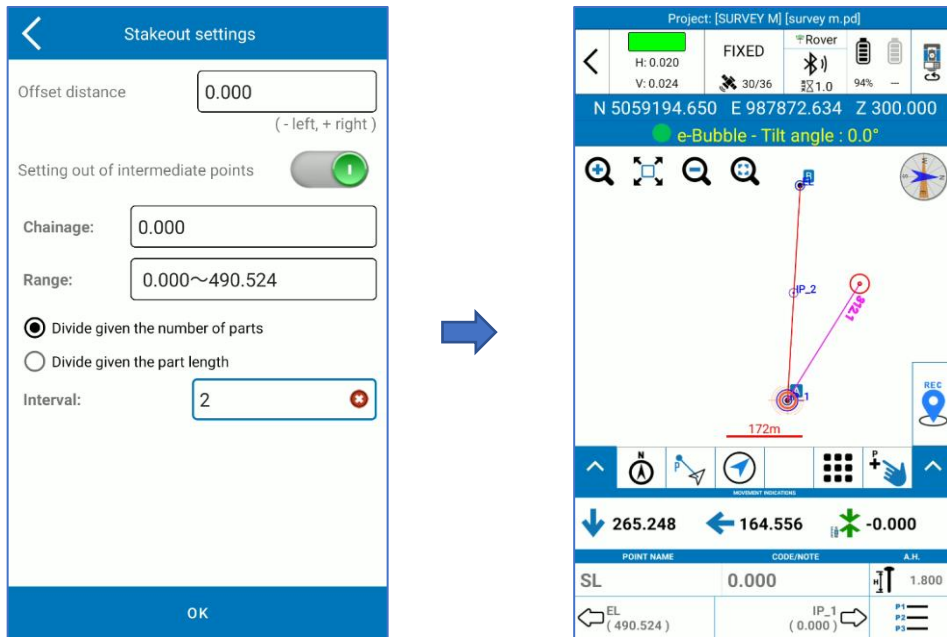

Click the icon in red in the following figure to stakeout specific points on the extensions of the line or on the shifted line.

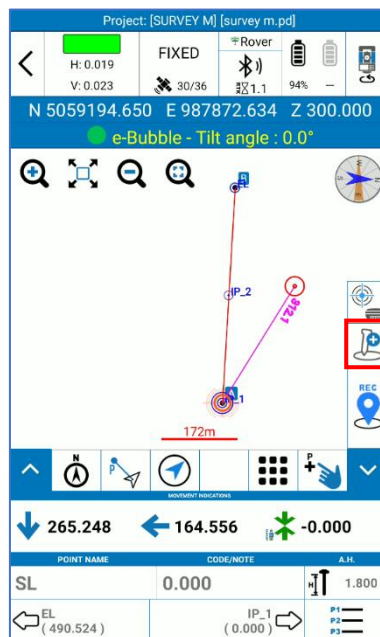

In the following example, the indications are for reach the point at chainage 0, with an offset distance of 100 meters on the right with respect to the line.

Add Stake

Add Stake Mode:

Calculate coordinates by chainage and offset distance

Calculate offset and distance by coordinates

Input Data:

Chainage:

Offset Distance:

Offset Angle:

Note: Allowed stake chainage range is (0.000 ~ 490.524);

OK



Project: [SURVEY M] [survey m.pd]

H: 0.019 V: 0.023 30/36 1.4 94%

N 5059194.650 E 987872.634 Z 300.000

e-Bubble - Tilt angle : 0.0°

172m

271.104 64.728 -0.000

POINT NAME	CODE/NOTE	A.H.
0.000		1.800
EL (490.524)	SL (0.000)	P1 P2 P3

Click the icon in red in the following figure to access the *Survey Tools*. In addition to the functions described in [7.7 Survey Tools](#) there are also the *Stake Line Settings*.

Project: [SURVEY M] [survey m.pd]

H: 0.021 V: 0.025 30/36 1.7 94%

N 5060572.584 E 984796.709 Z 300.000

e-Bubble - Tilt angle : 0.0°

9m

6.783 7.129 90.000

POINT NAME	CODE/NOTE	A.H.
---	---	1.800
(---)	(---)	P1 P2 P3

Stake Line Settings

Stake Line Configurations

Graphical aid indicators spacing:

Chainage Prompt Step:

Warning Range:

Display Track:

RESTORE DEFAULT SETTINGS OK

Graphical aid indicators spacing: is the space between the reference lines added to the side of the line to be Staked out.

Chainage Prompt Step: it is the step to view the progressive on the line.

Warning Range: Warns you if you are approaching the destination point when you enter within the defined distance value. If you move away, you are warned that you are moving away from the destination point.

Display Track: "View" to see the points of the last positions (shows the scrap of the route executed).

6.4 Stakeout by design lines

With this function, you can create parallel lines from one as a reference and stake out all lines.

To do this, open the function and select Add. Then select *Straight Line* to set the reference line.

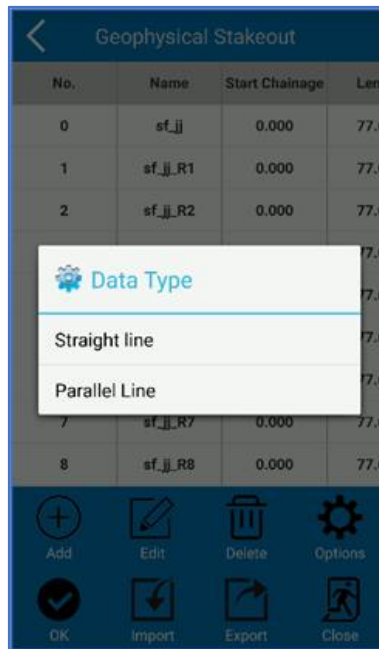

Set the start and end point and name the line.

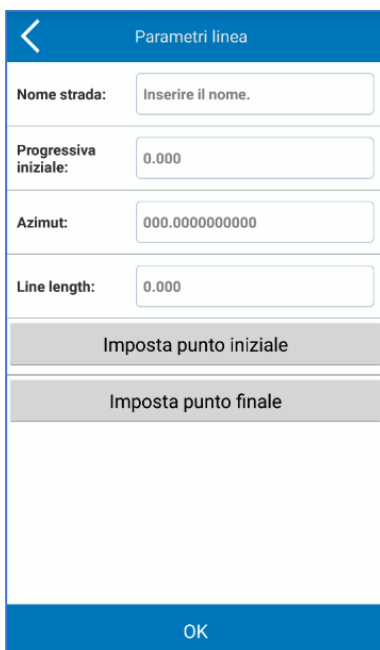

Nome strada:

Progressiva iniziale:

Azimet:

Line length:

Imposta punto iniziale

Imposta punto finale

OK



Inserire le coordinate del punto

Nome:

Nord:

Est:

Quota:

OK

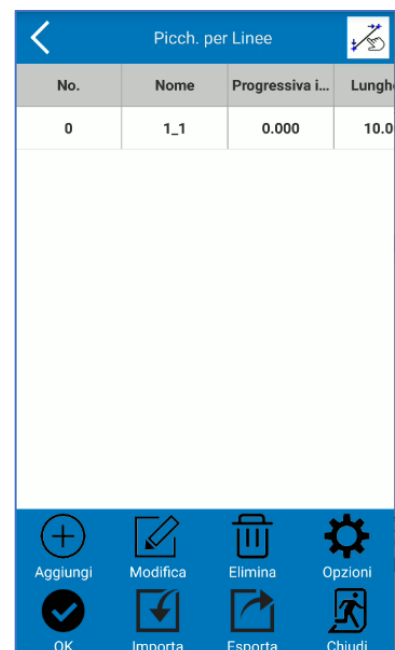

No.	Nome	Progressiva i...	Lungh
0	1_1	0.000	10.0

To create the parallel line, select the reference line and press *Add*. On the menu that appears, click *Parallel Line*. Then insert the Spacing (distance between the lines) and the number of parallels to the left and right.

After confirming, the user will have all the lines defined and ready for Staking out.

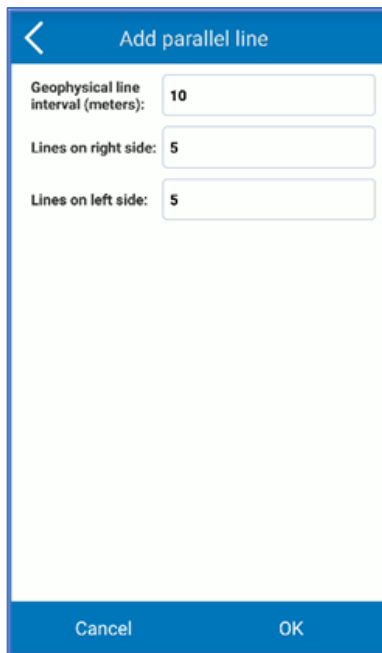
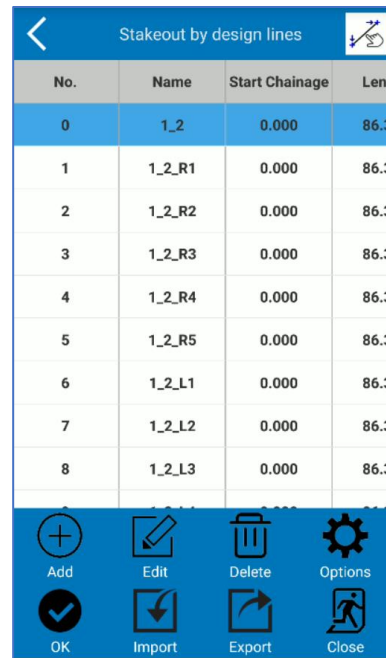
No.	Name	Start Chainage	Length
0	1_2	0.000	86.3
1	1_2_R1	0.000	86.3
2	1_2_R2	0.000	86.3
3	1_2_R3	0.000	86.3
4	1_2_R4	0.000	86.3
5	1_2_R5	0.000	86.3
6	1_2_L1	0.000	86.3
7	1_2_L2	0.000	86.3
8	1_2_L3	0.000	86.3

To start Staking out, select the line and press OK.

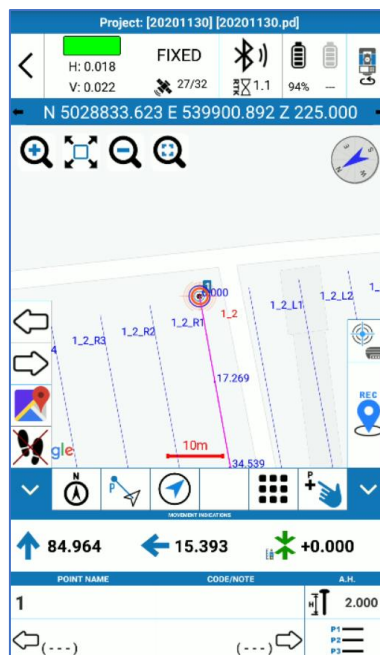

6.5 Elevation Control

The Elevation Control feature allows you to "plot in elevation".

First you need to select the file on which to check the dimensions. At the bottom, the "New" command allows you to create/import the file.

With the "New" command, you can import a Triangulated Irregular Network (TIN) file, in *.format. DXF. alternatively, manually add triangles (specifying the coordinates of the 3 vertices). Still define a plane for 2 points (a 3D point plus a 2D point plus the slope in the point-1 *direction towards* point-2) or define a plane for 1 point (a 3D point plus the north and east slopes). The "Import" command allows you to import a file with an extension *.TIN.

The tool displays the difference between the current GPS/Target height and the reference height.

If the height difference is positive, the program will show "Digging" followed by the absolute difference value: this means that to reach the reference height it is necessary to perform a "height cut", that is, dig the ground or simply lower the pole if it does not rest on the ground. If the height difference is negative, the program will show "Carry over" followed by the difference value, which means that to reach the reference height you need to perform a "height fill", that is, add some ground or simply raise the pole if you are only noting the reference height level.

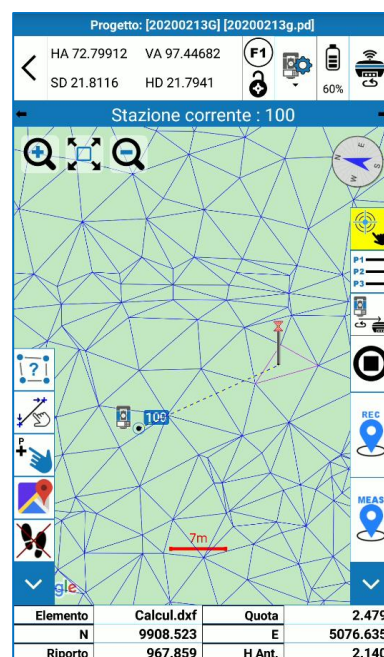
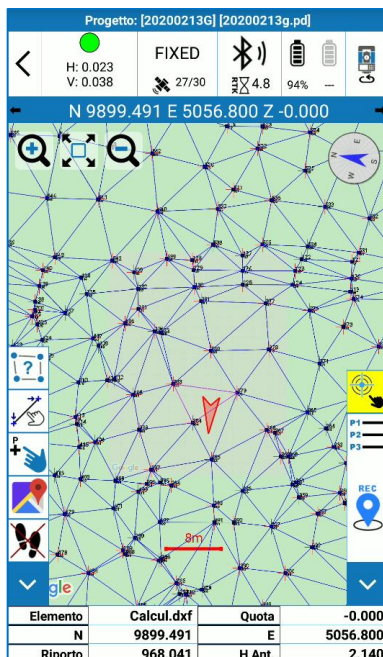

6.6 Road Stakeout

See [Appendix B – Road Stakeout](#)

6.7 Gridded Scan

This tool is available with TS module and R80 total station only.

It allows you to collect data within a defined area, following a regular grid.

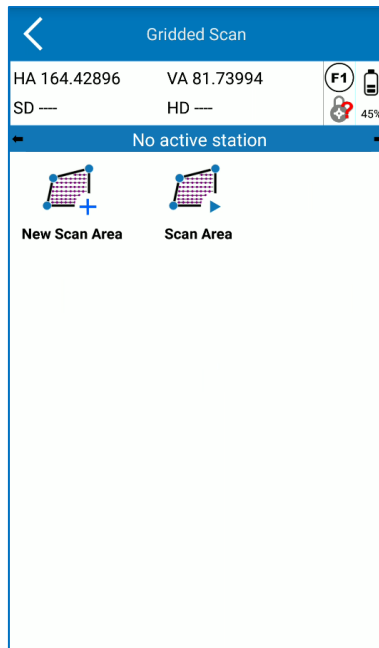

Before scanning, it is necessary to define the station position. In fact, by clicking on the Scan icons, you will see the following pop-up:

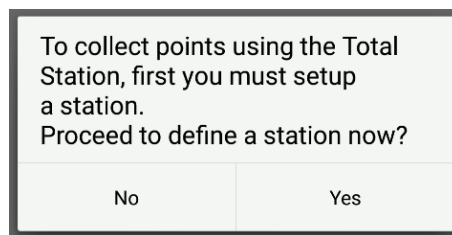

Click Yes to proceed defining the station position and go to [error](#) directly.

Defined the station, you can proceed by clicking on *New Scan Area*.

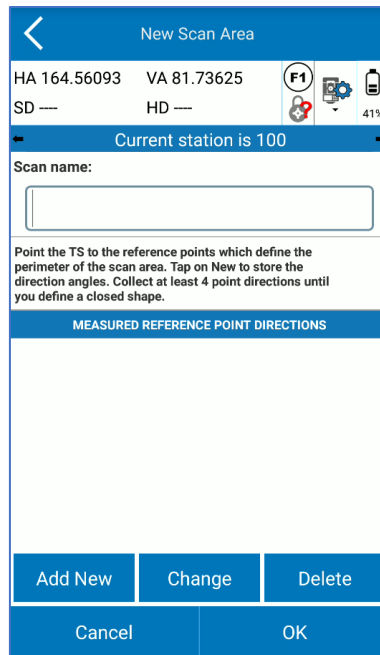

Here, click:

Add New to create a new point of the scan area. Before pressing it, insert a *Scan name*.

Change if you already have defined points of the area, and you want to modify the one you have selected (indicated by yellow)

Delete to delete an existing point of the area.

Adding a new point, you see the following page:

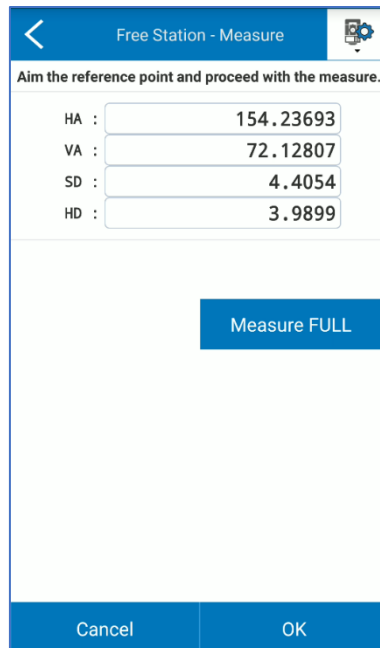

Where you can enter the total station control panel by clicking on  and measure the first point by *Measure FULL*. To confirm the point, press *OK*.

You will go back to the previous page with the resume of the measured points.

You need to have at least 4 points to close the area and can confirm pressing OK.

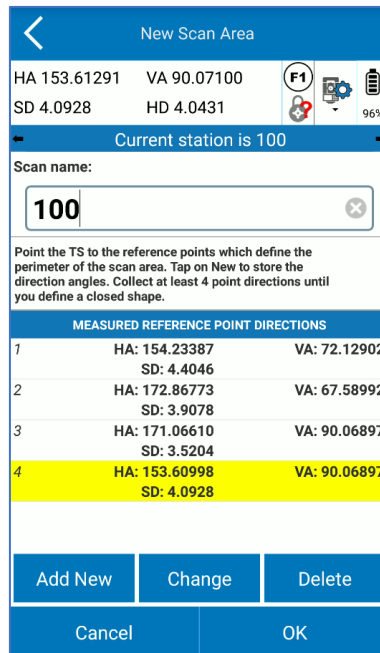

HA 153.61291 VA 90.07100
SD 4.0928 HD 4.0431

Current station is 100

Scan name:
100

Point the TS to the reference points which define the perimeter of the scan area. Tap on New to store the direction angles. Collect at least 4 point directions until you define a closed shape.

MEASURED REFERENCE POINT DIRECTIONS		
1	HA: 154.23387 SD: 4.4046	VA: 72.12902
2	HA: 172.86773 SD: 3.9078	VA: 67.58992
3	HA: 171.06610 SD: 3.5204	VA: 90.06897
4	HA: 153.60998 SD: 4.0928	VA: 90.06897

Add New Change Delete

Cancel OK

Now that the New Scan Area has been defined, press *Scan Area*:

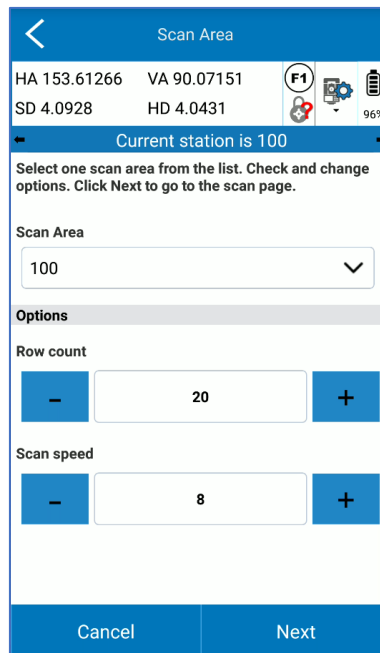

HA 153.61266 VA 90.07151
SD 4.0928 HD 4.0431

Current station is 100

Select one scan area from the list. Check and change options. Click Next to go to the scan page.

Scan Area
100

Options

Row count
- 20 +

Scan speed
- 8 +

Cancel Next

From the drop-down menu you can select the Scan Area defined in the previous step.

Choose the *Row count* and the *Scan speed*, considering that higher is the speed fewer are the collected points.

And click *Next*.

On the next page press *Start Scanning* and the instrument will start collecting points.

The screen shows the progression of the collection, indicating the number of points measured and the percentage of acquisition.

Press *Stop Scanning* if you want to stop the acquisition.

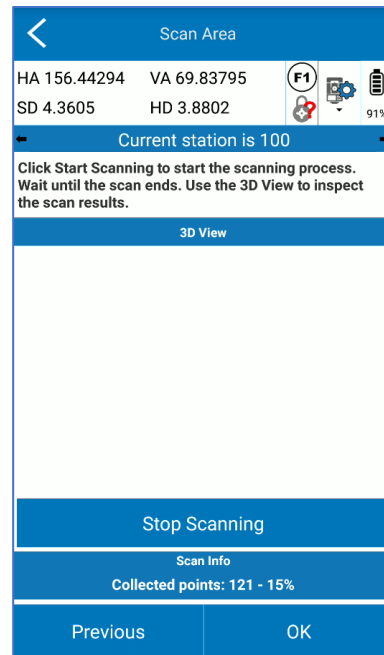
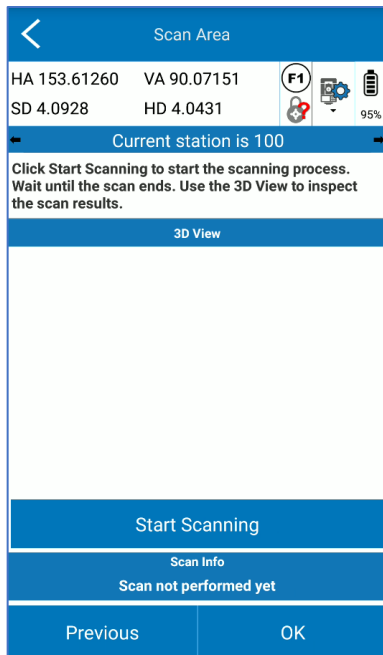

Data are automatically exported in the project's **TSScans** folder as a *.dxf

Cube-a preview is not available now.

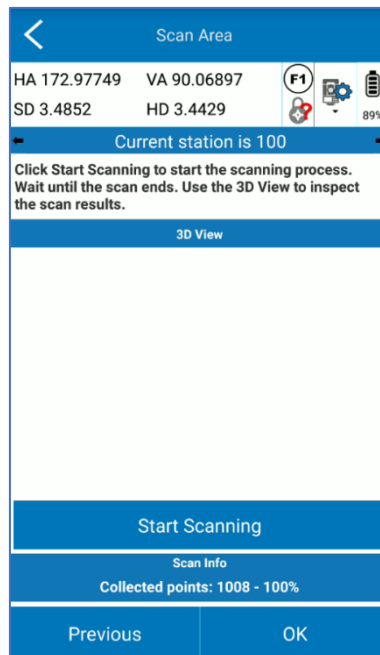

6.8 View in Google Earth

This tool allows you to view the active Survey using the Google Earth application, so it will also be possible to view in a 3D environment. To use this service, the Google Earth application must be installed on your device.

Note: CAD points and entities are "grounded", that is, heights are ignored and all elements are placed on the ground.

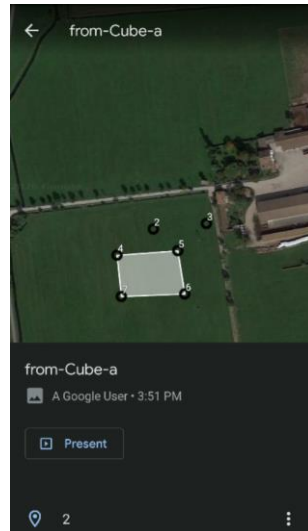
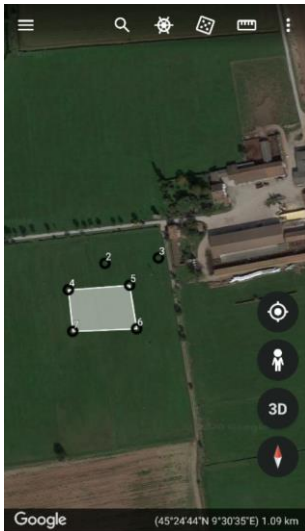

6.9 CAD

In the CAD environment you can use various SNAPS to draw or edit existing entities. The main CAD function are available: move, rotate, trim, scale, align, mirror and many other features described below.

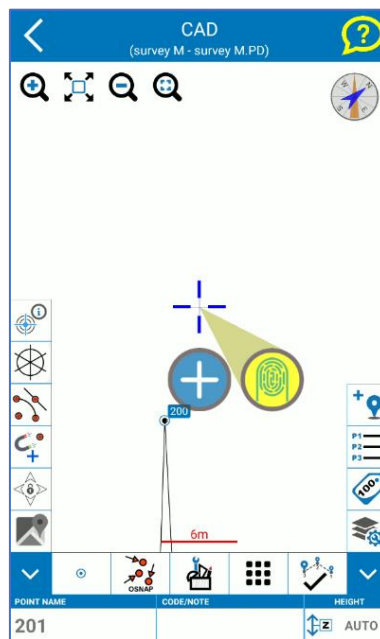

In the upper right there is the icon of a yellow question mark: hold down this icon to start a contextual help that allows you to remember, always, the meaning of the icons in the CAD area. Read the instructions that appear to use the help guide.

Zoom and compass icons at the top are described in [6.1 Point Survey](#).

The icons in the vertical bar on the left are described below. They turn yellow when enabled.



If enabled, displays the information for the selected entity.



If enabled, hides the points symbol.

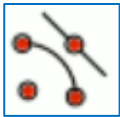

If enabled, turn on all snaps you choose.



If enabled, the cursor is automatically snapped to.



If enabled, snap the pointer to the map.



As in the survey area, enable a background map (e.g., Google).

The bottom fields for the point name and code are described in [6.1 Point Survey](#).

The icons in the horizontal bar are described below.

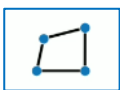

Choose the entity you want to draw (see [7.4 Draw during the survey](#)).

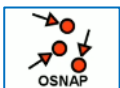

Choose which SNAPS to activate.

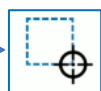

Select entities in a user defined area







Select the entities by selecting them one by one.



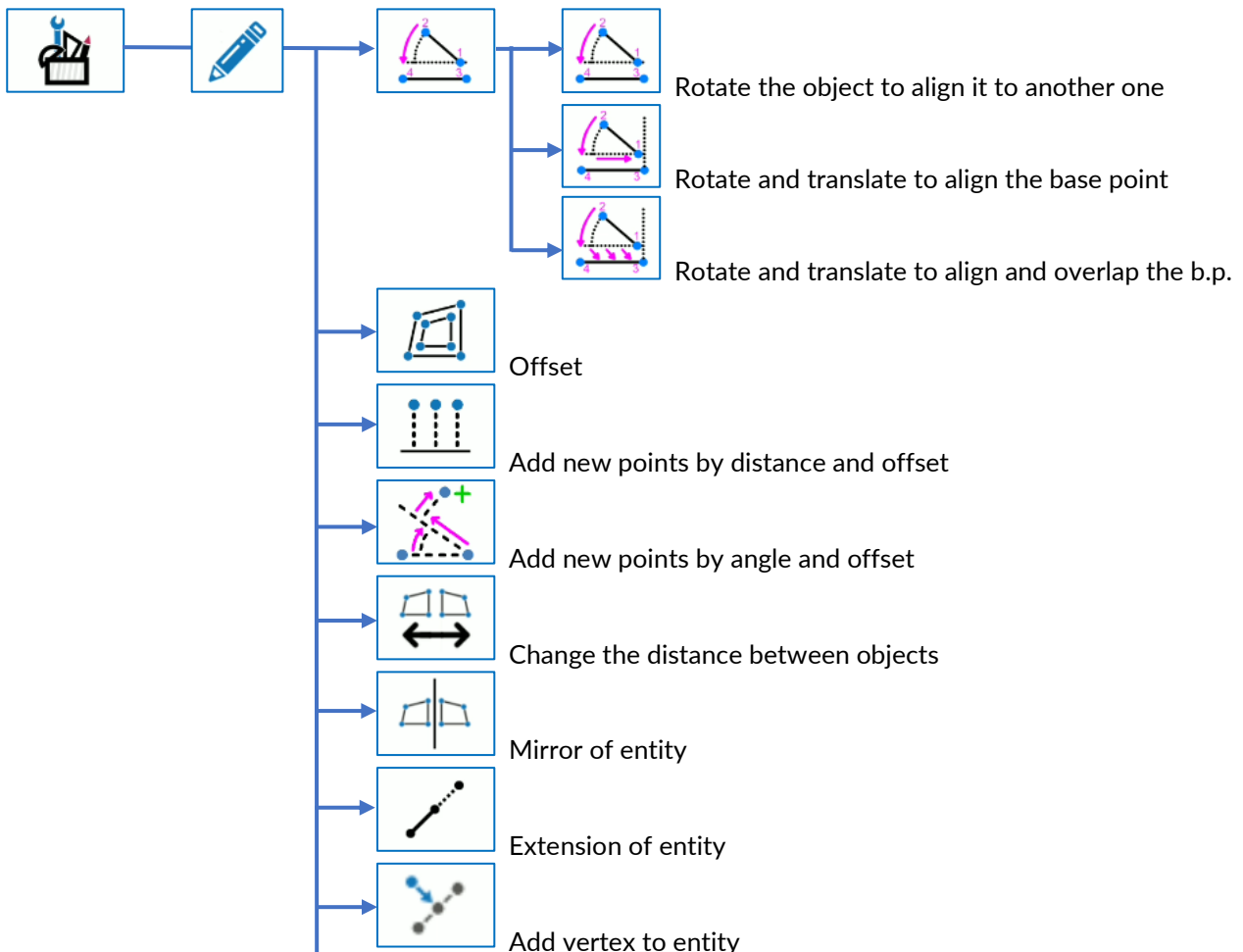
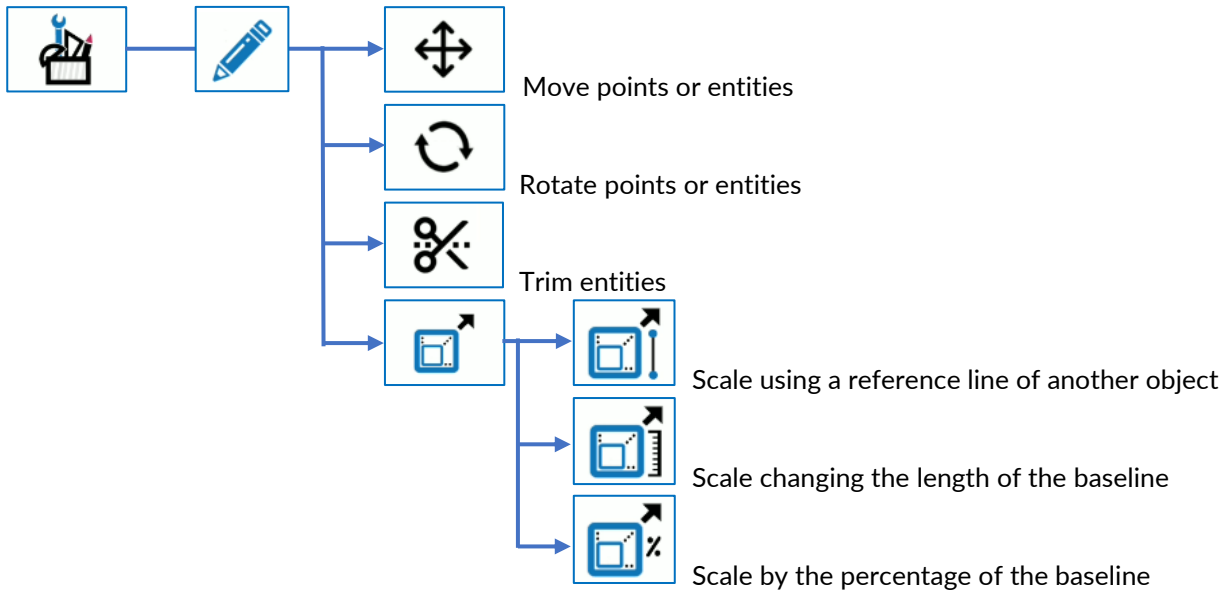

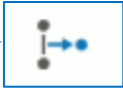
Select entities from entity list

Regarding the following functions, please read and follow the indications that appear in Cube-a while you are using the function, to select the right reference points or lines.



-  Remove vertex from entity
-  Move vertex of selected entity
-  Copy selected objects
-  Move selected objects to another layer
-  Delete selected objects

 View additional CAD tools

 End drawing (see [7.4 Draw during the survey](#)).

 Set point elevation

The icons in the vertical bar on the right are described below.

 If enabled, as you draw an entity, the vertices become points in the library.

 Open point library

 Click to make visible or not the point labels. Hold down to access to the [7.1 Display Settings](#).

 Click to access to the [7.2 Layers](#).

See [12 Appendix A – CAD Tools](#) for details on operating sequence in each CAD command.

7. Survey Options

7.1 Display Settings

Hold down the *point labels* button on survey area to access to the *Display Settings* page shown below.

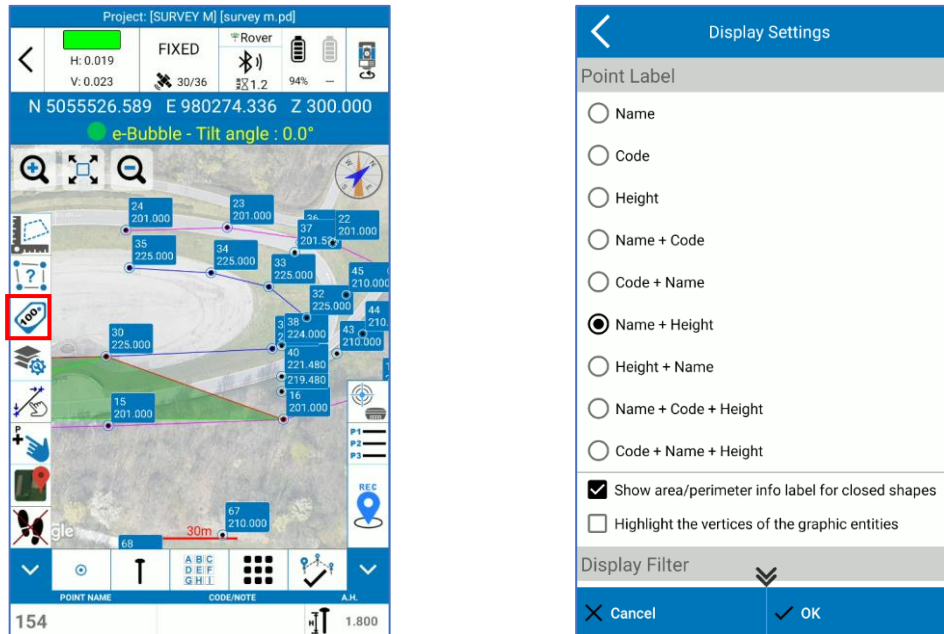

In this page you can choose the information you want to see in the point label. You can make visible the area and perimeter on survey area for closed entity (this is not for entity from external drawings you import). You can highlight the vertices of imported drawings. Finally, you can apply a filter to make visible only some points.

7.2 Layers

In the page *CAD Layers*, you can change the current layer (click on current), make invisible a layer (click on the lamp), lock a layer (click on padlock), change the color, line type and symbol associated. You can even create a new layer (click *New*) and rename or delete the layer selected. The default layer is layer 0 and it cannot be deleted.

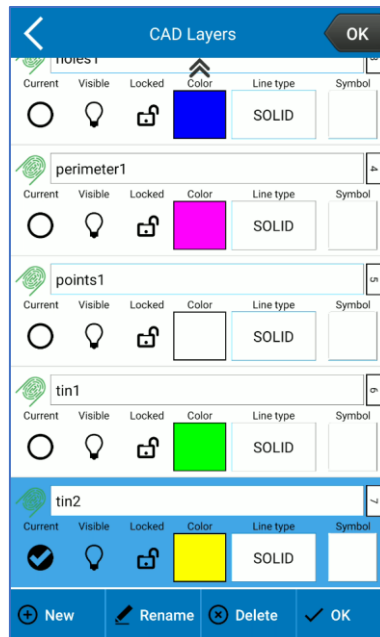

7.3 Background Map

Hold down the map icon in the survey area to access the Map Provider page.

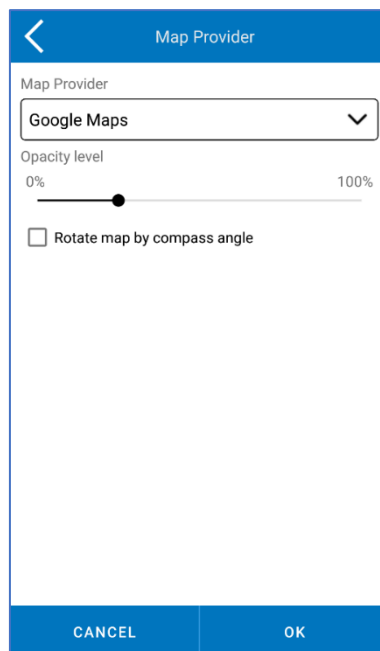

Here you can choose the background map between Google Maps, OpenStreetMap and Bing Maps.

The internet connection is mandatory. It's also possible to modify the opacity level of the map and rotate it using the compass angle; by enabling this last option the map will always be oriented in the same direction of the user movement, instead of being oriented in a fixed way towards the geographic North.

7.4 Draw during the survey

CAD entities can be drawn during the points capturing. Click the icon highlighted in red below to choose the entity. Blue points are the points needed for drawing. You can stop the drawing by clicking on another entity or by clicking *end the entity* button highlighted in green below.

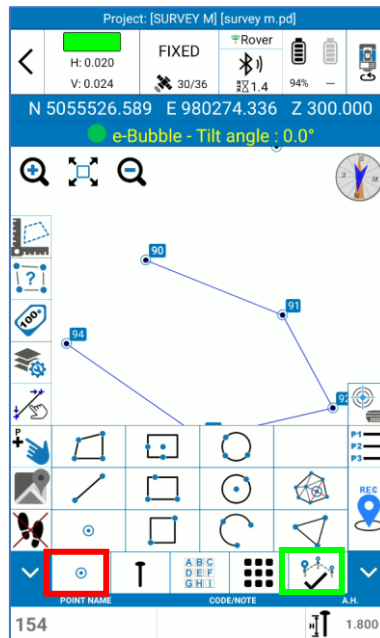

Point capturing. No CAD entities will be created during the point capturing. You can even draw after points capturing with Cad functions (see [6.9CAD](#)).



Polyline. Requires 2 points at least. While this function is active, Cube-a joins the points you are surveying in a polyline. If edges are more than one, when you click the *complete entity* button, the program asks if you want to connect the first and last vertices.



Polygon. Requires 3 points at least. While this function is active, Cube-a joins the points you are surveying in a polyline. When you click the *complete entity* button, the first and last vertices are automatically connected to draw the polygon.



Square. Requires 2 points only. Take the vertices of the square's diagonal to draw the square. The acquisition ends automatically as soon as the second point has been measured.



Rectangle. Requires 3 points only. Take 2 vertices to define two edges and a third point that determines the distance of the opposite parallel side so the remaining two edges. The acquisition ends automatically as soon as the third point has been measured.



Rectangle. Requires 3 points only. The first point defines the center of the rectangle, the second defines the middle of one side and the third the middle of the orthogonal side to the previous one. The acquisition ends automatically as soon as the third point has been measured.



Arc. Requires 3 points only. Take the starting point of the arc, a point of tie for which the arc passes and the endpoint. The acquisition ends automatically as soon as the third point has been measured. The three points must not stay along the same line.



Circle. Requires 2 points only. The first defines the center of the circle, the second defines the radius of the circle. The acquisition ends automatically as soon as the second point has been measured.



Circle. Requires 3 points only. Take 3 points along the circle. The acquisition ends automatically as soon as the third point has been measured. The three points must not stay along the same line.



Triangle. Requires 3 points only. Take the 3 vertices of the triangle. The acquisition ends automatically as soon as the third point has been measured.



TIN. Requires 3 points at least. Draw a TIN in the current layer with the points you are capturing.



End the entity. The action performed by this button depends on the type of active drawing function and how many points/vertices have been saved.

7.5 Point type

In the survey area there is the shortcut button for the point type.

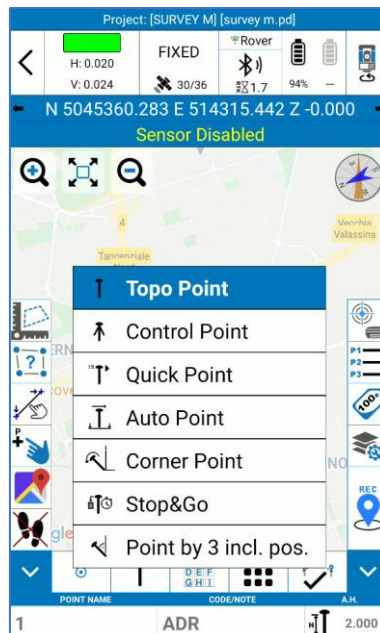

This function allows to quickly choose the point type according to the needs, so the user does not need to change the parameters to save different types of point each time. Example: during the survey, the user wants to save boundary points with the best possible accuracy (which means to stay a few more seconds on the point). The user should change the point parameters to make the checks more stringent and, once saved these types of points, he should reset the starting parameters, otherwise it would mean to stay more time on all the other points as well. Thanks to this function it is enough to change the point type and choose the one with the parameters already inserted that meets user needs.

The following types of point have default parameters, but the user can always change them.

Topo Point: "classic" point. It is possible to set the following control parameters: minimum solution, maximum horizontal and vertical root mean square, PDOP limit, maximum differential correction age, readings to mediate and interval (interval between readings).

Control Point: point with stricter controls, recommended when you want to obtain the maximum reliability possible at the cost of stationing extra time on the point. It is possible to set the following control parameters: maximum horizontal and vertical root mean square, PDOP limit, maximum differential correction age, planimetric and altimetric limit, readings to mediate, average GPS range, number of readings repetition and

interval. Example: if the number of readings is 10, the average GPS range is 2, the number of repetitions is 2, and the interval is 15s, then Cube-a performs 10 readings every 15s, the averages to 2 at a time and repeats the whole thing 2 times. When the saving is complete, you'll see the "report of generated control point."

Quick Point: quick points acquisition since the controls are fewer and, by default, less binding. It is possible to set the following control parameters: minimum solution, maximum horizontal and vertical root mean square, PDOP limit, maximum differential correction age.

Auto Point: this function allows you to automatically save points, so you do not need to click the rec button. It is possible to set the following control parameters: minimum solution, maximum horizontal and vertical root mean square, PDOP limit, maximum differential correction age. It is obviously necessary to choose the criteria for auto-saving; you can record according to step or time. If step is selected, it is related to meter or foot as per units' settings in Cube-a and the points are saved automatically depending on distance or height difference.

Corner Point: this function allows you to save a corner point (without resorting to geometric calculation by intersection) even if you do not have a GNSS receiver with tilt sensor. It is possible to set the following control parameters: maximum horizontal and vertical root mean square, PDOP limit, maximum differential correction age, readings to mediate. The acquisition consists in moving the pole drawing arcs around the edge holding the tip on the corner point; Cube-a makes average between these readings.

Stop&Go: point with no controls, to allow the user to save points even without differential corrections. You can enable the recording of raw data and set the number of epochs. This function is suitable for saving points in bad conditions to perform the post-processing in the office.

Point by 3 inclined pos.: this function allows you to save a corner point (without resorting to geometric calculation by intersection) even if you do not have a GNSS receiver with tilt sensor. Attention, you need a GNSS receiver with electronic bubble. It is possible to set the following control parameters: maximum horizontal and vertical root mean square, PDOP limit, maximum differential correction age, readings to mediate and interval (interval between readings). The acquisition consists of making three readings with the pole tilted in three different directions; Cube-a intersects the three spheres resulting from these three readings.

In some types of point you can enable quick mode. If you do not enable this option, after you click on rec, a window appears, which allows you to associate a photo to the point, change the code or height of the pole (you can also do these operations later from points library), check much information about the point and cancel the record. If you enable quick mode, the point is saved immediately, as soon as you click rec.

7.6 Photos and Sketch

The *Photos and Sketch* command allows you to associate a photo with a point.

To start *Photos and Sketch*, press the key at the bottom of the screen while you are:

- Checking the details of a newly collected point.
- Changing the data of a surveyed point library.

The photo will be taken using the built-in camera of the device and is saved as a .jpg file in the *Photos folder* of the project used.

The name of the image will be the same as the point.

You can also draw over the photo and add:

- Text notes.
- Point information (name, coordinates)
- Arrows
- Hand-drawn sketches.

Anything can be moved or rotated on the image.

Images can also be redone or deleted.



7.7 Survey Tools

Click on the icon with nine squares in the survey area to access to the *Survey Tools* page shown below.

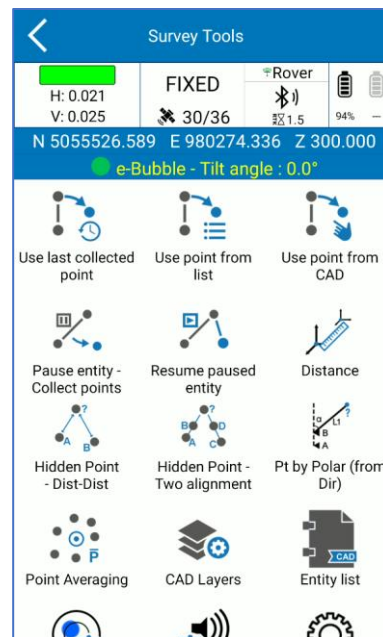

The survey tools functions are described below.

Use last collected point

Click to use the last collected point as first point of the entity you are going to drawing, then you will be back on the survey area.

Use point from list

Click to use a point from library as point of the entity you are drawing, then the point library will open to let you choose the point.

Use point from CAD

Click to select a point from CAD area to use it as point of the entity you are drawing.

Pause entity – Collect points

Pause the entity you are drawing, so you can take some point that is not a vertex of that CAD entity.

Resume paused entity

Resume the last paused entity to continue to draw it.

Distance

Calculate the distance between two given points. Points setting options available:

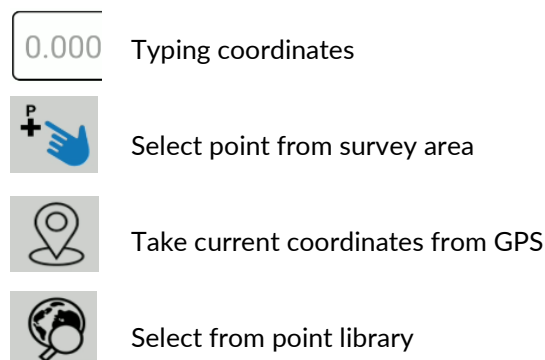

Hidden Point – Dist-Dist

Calculate the hidden point by two given points and the distances between the two points and the unknown point.

Within the command, at the top, there is a brief description of what you must insert to perform the calculation and what is the result.

Hidden Point – Two alignment

Calculate the hidden point by four given points.

Within the command, at the top, there is a brief description of what you must insert to perform the calculation and what is the result.

Pt by Polar

Calculate the hidden point by two given points, the angle and the length.

Within the command, at the top, there is a brief description of what you must insert to perform the calculation and what is the result.

Point Averaging

Calculate the average point. Click *Start* to start taking coordinates then click *Save* to save the point obtained by average of taken coordinates.

CAD Layers

See [7.2Layers](#)

Entity List

See [11.1Entity List](#)

Sensor Options

See [9.5Sensor Options](#)

Audio Settings

See [8.5System Settings](#)

Record Settings

See [7.5Point type](#)

Display Settings

See [7.1Display Settings](#)

8. Configure

This menu contains all the functions useful for configuring the Cube-a program, configuring some parameters of the current project, such as the reference system, and importing external drawings such as layers.

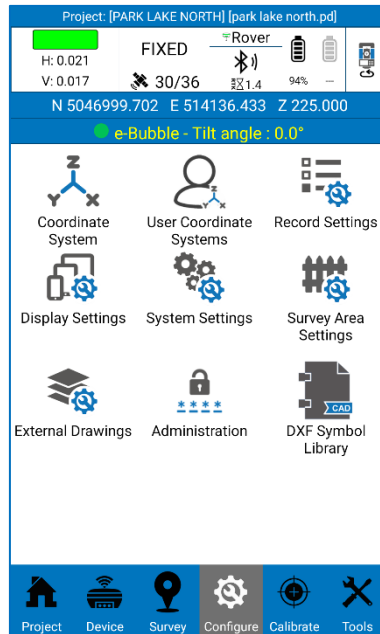

8.1 Coordinate System

By clicking on The Reference System, in the Configure menu, opens the Reference System Parameters page, where you can check the reference system currently in use and modify it. It is not necessary to modify the parameters listed below (Ellipsoid, Projection, ...), except for specific needs that require the customization of these parameters, since the program defaults to the main reference systems in use worldwide. Click Existing Use/Change and then on Default Systems to access this list; you can search for the reference system by filtering by country or by word. By clicking on *Details*, you can read the parameters of the selected reference system. To choose and set up a reference system from the list of default systems, select it and click OK.

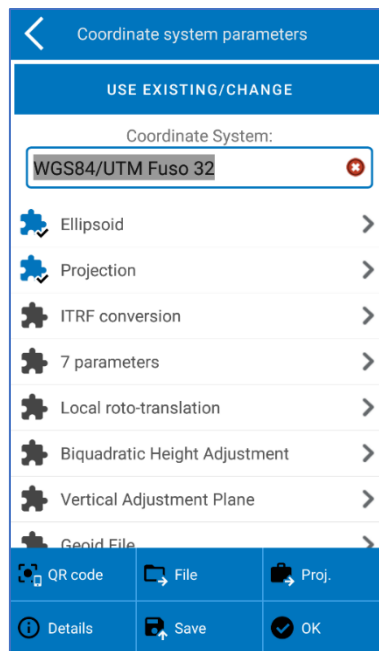

By clicking on "File" you can import a reference system saved on the device (*.files are supported. SP and *. EP); by clicking instead on "QR code" you can scan the QR code and acquire the parameters of the coordinate system in this way.

The following are the parameters of your reference system listed on the Reference System Parameters page.

Ellipsoid: This command opens a page where you can choose the name of the ellipsoid that supports parameters that have already been defined or choose a customizable ellipsoid. In the latter case, you must choose Custom at the bottom of the "Ellipsoid Name" drop-down menu; you can then set semi-major axis and flattening ratio 1/f.

Projection: This command opens a page where you can choose the projection. Using gauss krüger projection, for example, you need to set the central meridian; this is automatically entered by the program if you are already connected to the GNSS receiver, using the position transmitted by it, otherwise it can be entered manually or, after connecting the GNSS receiver, the central meridian can be inserted by the program by clicking on the drop icon (icon to the right of the Central Meridian drop menu).

ITRF Conversion: This command opens a page where you can enable conversion between International Terrestrial Reference Frames (ITRF) with different reference eras. To enable ITRF conversion, you must choose the type of conversion, enter the reference era, and enable or disable speed entry; If you enable speed, you must insert the speed components along the axes. X, Y, Z. Attention, this conversion is applied to all points in the current project, and not just from the moment you enable it.

The **7 parameters**, **Local Rototranslation**, **Biquadratic Height Adjustment**, **Vertical Adjustment Plane**, **Local Offsets** commands contain translation, rotation, and scale factor values when expected from your localization.

Geoid files: This command opens a page where you can enable the use of the geoid. By clicking Open on the "Geoid Files" page leads to the list of preloaded geoids in the program. To add a geoid that is not in this list, copy the file to stonexcube -> Geoid; Cube-a supports all major standard geoid formats (*. GSF, *. GGF, *. UGF, *. BIN, ...).

Click OK to apply the chosen reference system. Click "Save" and choose "Local Disk" to save the system data to a file whose name and location you have defined. You can also encrypt the file by setting an Expiration Date,

General Password (data cannot be displayed before expiration date), and Advanced Password (data can be displayed before expiration date). Click "Save" and choose "QR Code" to share the parameters of the current coordinate system via QR Code.

8.2 User Coordinate Systems

In the sub-menu User Coordinate Systems there are all the systems created by the users or chosen from the predefined and recently used ones.

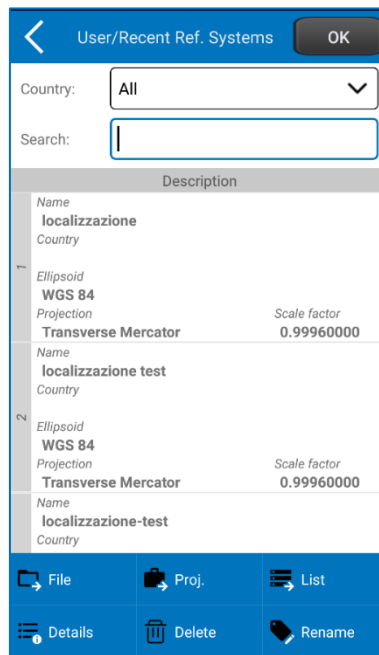

8.3 Record Settings

By clicking on logging setting, from the Configure menu, opens the relative page, where you can set the parameters for saving the various point types. see

Code: You can set the code, by default, to be empty or equal to the last point, or as a mileage assignment code.

Point name increment: Auto-naming rule for saved points. For example, if you choose 2 in the drop-down menu, the point names will be auto incremented by two units, each time you save the point.

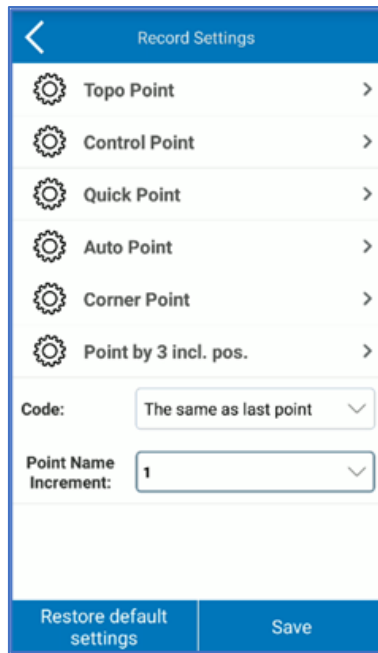

8.4 Display Settings

See

8.5 System Settings

The following figure shows the system settings, which we will see in detail below.

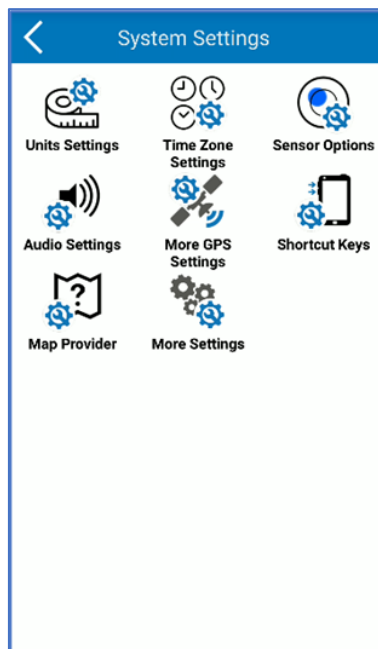

Units Settings

In this section, you can define the units of measure that you want to use in Cube-a.

Time Zone Settings

You can set a time zone through the appropriate drop-down menu. The time zone is used to bring GPS time back to local time. If not set differently, Cube-a uses the system time zone.

Sensor Options

This command accesses the same page as described in section [9.5 Sensor Options](#)

Audio Settings

This command enables/disables voice alerts and sounds expected in the program, as well as receiver alerts.

More GPS settings

The user can choose to work in *Normal* or *Precise Mode*. The precise mode consists of a more accurate search for the FIXED solution, but at the expense of speed. The maximum achievable accuracy will be the same, but the solution will be much more reliable.

In the case of GNSS receivers with Novatel board, the precise mode enables "extra-safe" mode; in the case of GNSS receivers with Hemisphere card, the precise mode enables "SureFix" mode.

With the function called L-band Zone you can set the reception zone of L-band frequencies, normally receivers select the zone automatically (available only for GNSS receivers with Hemisphere card).

From this screen you can also activate the Wi-Fi of the receiver.

Shortcut Keys

Shortcuts can be set for some Survey and Stake out functions. The possible settings can be: *Nothing*, if you do not want to associate any shortcut key, *Vol UP* or *Vol DOWN* to associate the Volume button, *Custom* allows you to associate a button of your choice, the first one you press, after selecting the item "Custom".

Map Provider

See paragraph [7.3 Background Map](#)

More settings

The command allows you to enable fictitious locations, i.e. the location of the device (and all the applications present that use its data) will follow the coordinates of the connected GNSS receiver (and not those of the internal GPS).

8.6 Survey Area Settings

Click "Add" to set the coordinates of the point or search for coordinates in the points library or use the current GPS coordinates. Generally, the area of investigation needs at least three points. Points can be chosen, edited, or deleted. Click "Import" to import coordinate files (*.dat, *.txt, *.csv). The survey area, after setting, is visible as a figure with red lines, so you can visibly check if the current point is in the set area.

PointName	Northing	Easting
44	4831351.345	697203.990
10	4831393.578	697279.216
30	4831394.815	697332.099



8.7 External Drawings

This command allows you to import DXF or Shapefile files into your program in the form of layers. As a result, points will not be imported into the library, only in graphics. However, you can select points and entities from the graphics and use them for tracking. Click "Add" to select the file you want to import. The "Edit" command allows you to change/read the name of the imported external drawing, read the location of the file in the data store, enable/disable visibility, enable/disable the selection of items in the layer, such as lines and points ("Find" command), and set the unit of measure and scale factor.

Warning: These files will be imported into the program and will be visible in all projects until you make them invisible or delete them, they are not constrained to the current project.

8.8 Administration

On this page, you can change the password visibility settings in Cube-a (such as those for your CORS account). You can also protect this screen so that visibility settings are protected themselves and accessible only by a password administrator. The last field at the bottom, if left blank, from free access to the function, if instead a password is entered, to access this function again you will need to enter the password.

8.9 DXF Symbol Library

On this page, you can import or create a symbol library so that you can associate them with layers, and then you can save points with different symbols in the survey area. The program defaults to a standard library containing 23. Within the selected library, the user can preview the available symbols.

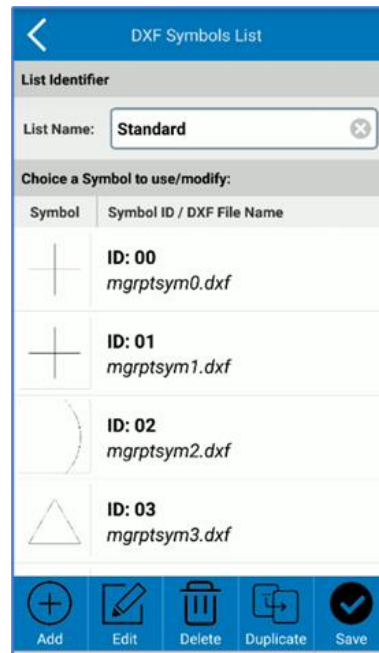
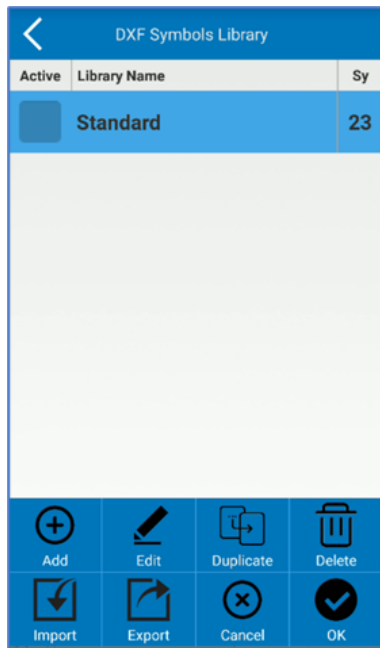

The user can select a symbol and edit it, changing scale, rotation, color, and shape.

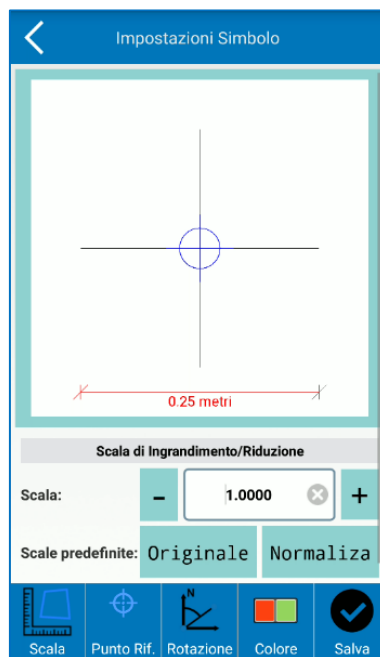

9. Calibrate – GPS Module

The *Calibrate* menu, in the GPS mode, contains functions useful for calibrating the survey or the instrument.

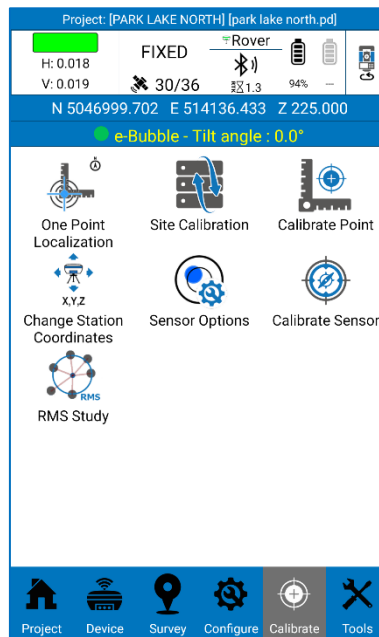

9.1 One Point Localization

The function one point localization is useful when you want to obtain the real distances between points, therefore not affected by the deformation of the projection of the GPS reference system. This function is necessary when you want to compare the GPS survey with a total station survey.

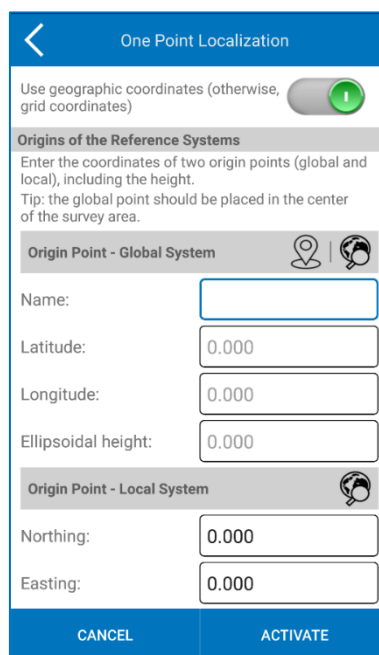



The function consists in assigning to a point, preferably central to the survey, the local coordinates that will represent the origin of the new local system.

By default, the program asks for geographical coordinates in the global system of the origin point; if you want to enter map coordinates (North, East) then disable the option at the top *Use geographical coordinates*. In the global system section, you can manually enter the coordinates of the origin point or detect them in real time from the GNSS receiver (click on record point) or select them from the point library (click on search). In the local system section, you can manually enter the coordinates of the origin point or select them from the point library (click on search).

It is also possible to define a point for the orientation of the new local system (as you are used to working with the total station); this is not mandatory, and if you ignore this section then the local system will be oriented towards geographic north.

Click *Activate* at the bottom to create the new local system.

9.2 Site Calibration

Cube-a offers the possibility to localize, i.e., convert outbound coordinates from the GNSS receiver, into an unconventional reference system. The screen for this feature is shown in the Figure below. At the top are the points that will be used to calculate localization, the points can be added to the table by pressing the "Add" command at the bottom. The screen to add is the one shown in Figure. Here you can enter the known (local) coordinates, on which you want to locate, these can be entered by hand or by selecting a point in memory with the selection commands . The conversion's target coordinates are below and can be collected from the current GNSS location or selected from a point in memory . The options below the coordinates provide the ability to enable planimetric and/or altimetric localization.

The localization points you add can be changed with the "Edit" command, under Figure, at the bottom.

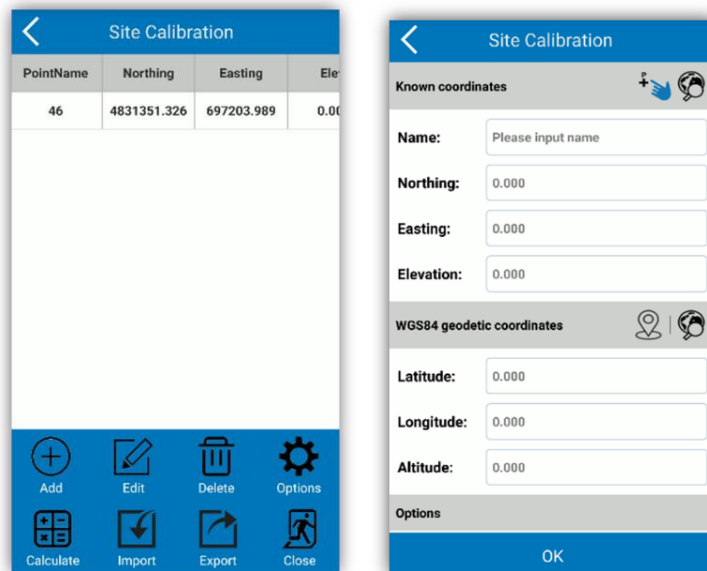

Added the point (or points) for localization, you can perform the conversion. There are three methods of converting coordinates: Inclined plane + Delta dimension (Roto-translation), 7 parameters + Inclined plane + Delta quota, 7 parameters, click the "Options" command in Figure, to access the reference screen in Figure.

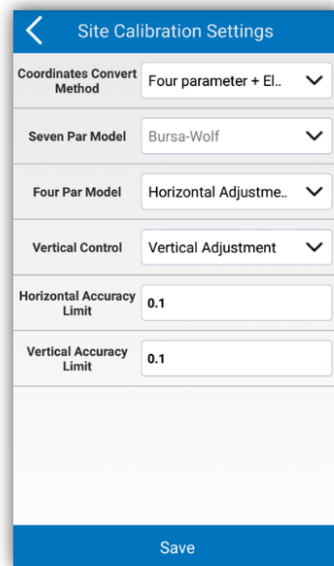

In the figure above, you can set one of the expected conversion methods. In case of 7-parameter conversion calculation, you can set the Helmert or Bursa-Wolf model, for the management of the sign of the roto-translations parameters. For the 4-parameter model, you can set up a barycentric or non-barycentric roto-translation. And finally, you can set the quota control and a horizontal and vertical accuracy limit. By clicking the "Save" command at the bottom, the options will be saved for calculation.

Below is a brief description of the calculation methods 4 parameters and 7 parameters.

4 parameters: At least two Control Point related to an arbitrary coordinate system must be known. It is the coordinate transformation mode used to perform a conversion between different coordinate systems within the same ellipsoid. Parameters include four values (north translation, east translation, rotation, and scale), the scale must be infinitely close to 1.

In general, the distribution of control points directly determines the quote difference and the four parameters to be controlled. The use of four parameters for the RTK measurement method, can be used in a reduced area (20-30 square kilometers). Measure a point in flat coordinates and operate in the precision of a control network with dimensions of known points. The more known points you will have, the higher the accuracy (2 or more than 2). But in a very large point distribution (e.g., tens of kilometers), the 4 transformation parameters often do not help, in this case to have an increase in precision both in the planimetric coordinates and on the altitude should use the 7-parameter transformation.

First, you need to perform a static survey in the area where the cornerstones are present, and then select a cornerstone A as a static reference station (in WGS84), which will be used to correct the point network. Use a static receiver to measure a single fixed point for more than 24 hours (this step, in test zones you can perform in less time and in case of low precision required this step can also be omitted) and then import into the software, as a single point all the captured data, the average of the readings will be the actual coordinates of point A in WGS84 coordinates. Absolute accuracy should be below 2 meters, so regarding adjusting the three-dimensional control network, you need to take point A WGS84 as the cornerstone to calculate the 3D coordinates of other points. The 4-parameter model, used to perform a 2D transformation, can achieve a barycentric roto-translation (around the midpoint of the source coordinates, called "Vertical Translation") or a non-barycentric roto-translation (around the origin of the axes, called the "Inclined Plane").

When the 4-parameter model is used, vertical correction will be automatically enabled.

The actual vertical correction parameters used depend on the number of points used. If less than 3 points are used, the heights are adjusted using the average corrections on the 3 points indicated.

If 3 to 6 topographic points are used, an inclined plane is calculated. If more than 7 points are used, a paraboloid surface is used.

7 parameters: At least three cornerstones, relating to an arbitrary coordinate system, must be known. It is the coordinate transformation mode used to perform a rectangular transformation of spatial coordinates between different ellipsoids. The parameters include seven values: 3 translations, 3 rotations and the scale factor (ΔX , ΔY , ΔZ , $\Delta\alpha$, $\Delta\beta$, $\Delta\gamma$, scale).

How to calculate conversion parameters?

Generally, use 3 known points (A, B, and C) to calculate parameters, so first you need to know the WGS84 coordinates and local coordinates of the 3 known points (A, B, and C). There are 2 methods to get the WGS84 coordinates of points A, B, C. The first method is to set the static control network and then obtain WGS84 coordinates from the GPD capture of the post-processing software. Second method, the GPS Rover records the original WGS84 coordinates in a fixed solution when the correction parameters are not active.

After entering all the points for localization, click " Calculate "to perform the operation and a report will appear containing the calculated GPS parameters. Click "Back " to return to the previous interface, then click "Close" to exit from localization. A message will appear before you exit asking if you want to use the calculated parameters for the current project. You can confirm or exit without saving the calculation. When a localization is saved, Cube-a asks you to set a name for the new reference system, and the " Reference System " command has an alert, which reminds you that localization is active in the current project.

After you apply the conversion parameters, the original coordinates in WGS 84 in the points library of the current project will be converted to the coordinate system based on the calculated conversion parameters. To verify that the results are accurate and precise, you can perform a check by logging in from another known point.

Click "Import" to import files *.cot or *.loc, (extension import coordinates).

Click "Export "to export and save coordinates localized, in a file with a *.COT. The coordinates can then be used in the future, without having to reinsert them.

9.3 Calibrate Point

Click "calibrate" then "Calibrate Point", to access the interface shown in the figure. The program has two methods to calibrate the station: *base point calibration* and *marker point calibration*:

Base Point Calibration:

Enter the coordinates of the known point (i.e., known coordinates before conversion); can be entered from the points library or manually. Then click the command alongside the "Current Base Coordinates" , to set the antenna parameters. Proceed to the calculation by pressing "Calculate" (a pop-up window with the mart displacement deltas will be displayed).

Note: Station calibration should be done in fixed solution.

The "Base Information" command below gives you access to location functions, already illustrated in the paragraph on the infobar.

Marker Point Calibration:

Place the coordinates of the known point (manual or library in memory) and coordinates in WGS84 (as the current location of the GNSS or from the library in memory). Click "OK" to perform the operation and view the result with the displacement deltas.

Click "View Local Offsets ", to see the current deviation.

Calibration of a station should be done based on the transformation parameters already calculated.

Below are the cases where the calibration of the station must be performed.

If the " Use Current Coordinates "option is selected in the start parameters of a base, the Rover should calibrate the station if the base has been restarted or the location has been changed.

When the user knows the workspace conversion parameters, the base can be calibrated to any location. However, the conversion parameters must be entered, and the Rover will then calibrate the station.

If "Input Base Coordinates" is selected at base startup and the base has been moved, then the Rover should calibrate the station.

If the entry " Input Base Coordinates " is selected when starting the base, and if the base is in the same position, then it should be enough to turn the device back on, without the need to calibrate the station.

Station calibration parameters do not update the current point coordinates in the library. When the current coordinates are shown, the calibration parameters of the station will also be shown, the next coordinate measure will be corrected according to the calibration parameters of the station. The transformation parameters obtained from calculating parameters from the library will update the coordinates of the current point. The WGS84 coordinates of the measured point are converted to local coordinates, using conversion parameters.

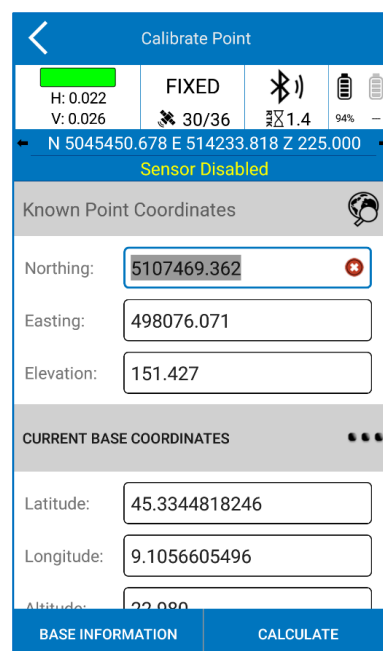
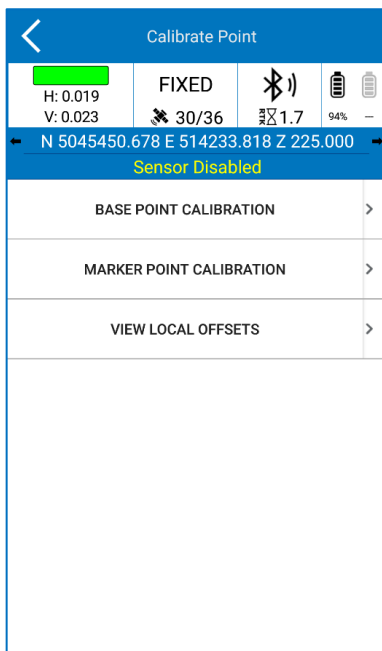

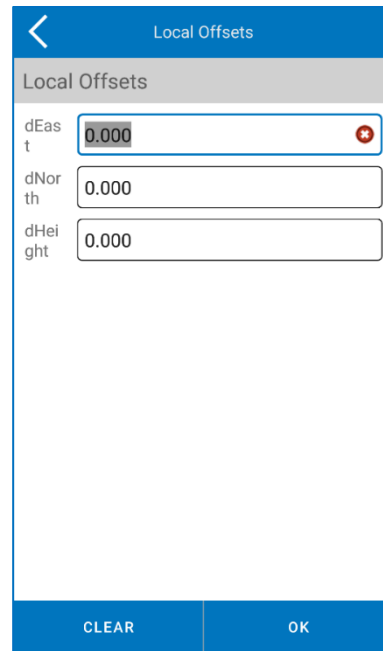
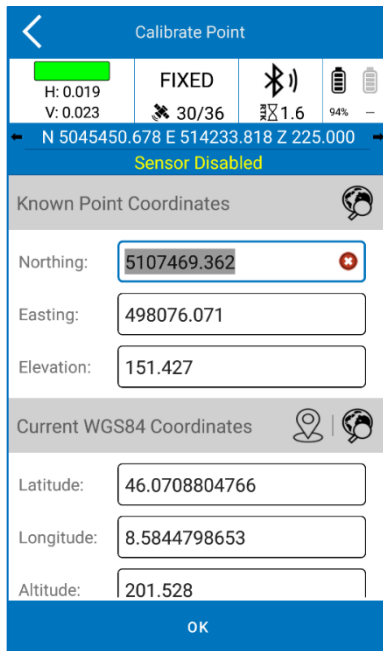

9.4 Change Station Coordinates

This feature is useful in Basic-Rover RTK working mode. When you save a point with the rover, Cube-a always saves the coordinates of the point base. So, if you want to move the base to a different place, you can use this function to calculate the coordinates of the saved points to keep the same length as the baselines.

Warning: The function is in BETA PREVIEW. It is not recommended to use it in real survey to avoid possible data loss.

9.5 Sensor Options

The user can enable/disable the use of the electronic bubble/IMU following the configurations available on his receiver. To enable the electronic bubble/pole tilt correction, simply select the option and confirm. In the menu you can also define the maximum limit angle within which to consider the vertical pole. So, this value will be the tolerance for the verticality of the pole during Survey.

You can also set the automatic collection of points if the pole is assumed vertically with respect to the set limit.

You can show the angle of the receiver inclinometer live during the Survey.

If the user prefers, there is an opportunity to show animations for IMU sensor initialization every time they lose calibration during the survey. Once the user is practical with the sensor, he can disable the option for the help of calibration.

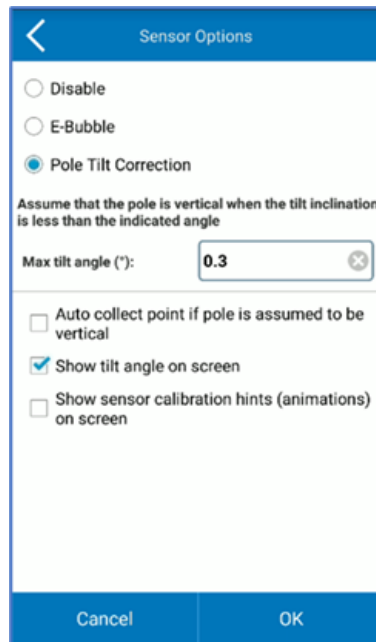

9.6 Calibrate Sensor

The Sensor Calibrate page depends on the connected GNSS receiver.

Stonex receivers equipped with new IMU technology

Follow the instructions shown to perform the calibration.

A fixed GNSS solution is mandatory for calibration.

Check the antenna height: an incorrect antenna height will make the calibration inaccurate.

Once you have checked the parameters described above, select the Calibrate Sensor option. A screen like the one in the figure will open, then wait for the message *Ready to calibrate*, start the calibration by clicking Start.

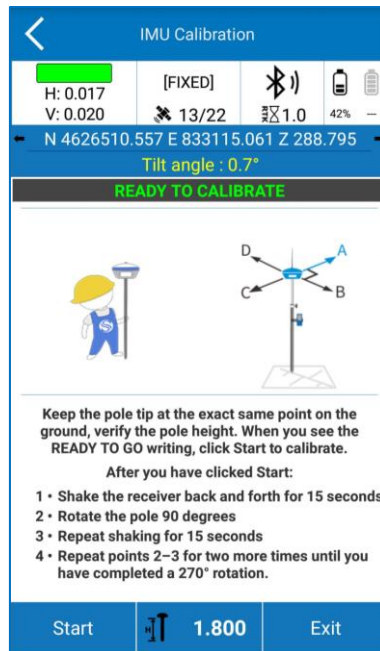

As shown in the following image, to calibrate the sensor correctly, you must first choose an arbitrary direction as a reference (direction A), then start moving the receiver back and forth along that direction until a message appears asking you to change the direction.



Then turn the receiver 90 degrees clockwise, reaching the direction $A+90^\circ = B$, and continue moving back and forth in the device.



This operation must be repeated three times, then every 90 degrees up to a total of 270° clockwise.

After moving the device back and forth along the D direction, the message Calibration completed will be displayed.

If calibration fails, an error message will be displayed. In this case check the conditions and repeat the calibration procedure.



9.7 RMS Study

You can check the accuracy of the inclinometer compensation by verifying the standard deviation. If the accuracy is good, you can continue to work, otherwise calibrate the sensor through the Calibrate Sensor function. The Standard Deviation Test carries out the study of the quality/precision of repeated measurements (keeping the tip of the pole in the exact same position on the ground).

How to use it? Open the command and click Start to start the measurement collection.

The application collects points with an average frequency of 1Hz. The collected positions will be mediated, and the standard deviation will be calculated. At this point, the operator can choose to procedure with calibration or continue the survey.

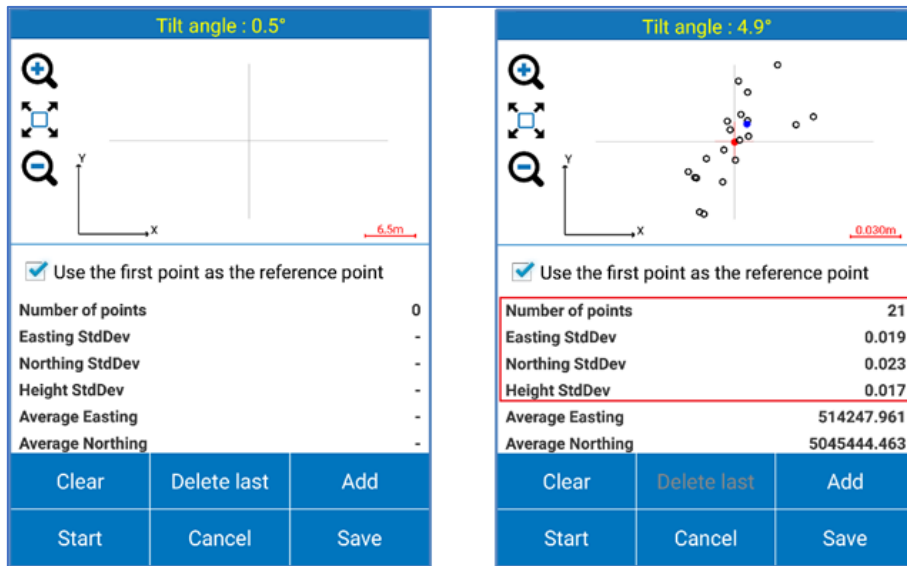

The user has control over the number of locations used in the calculation, and when he decides to end the control, he can press Stop to stop the automatic capture.

As mentioned, if the evaluation leads to unsatisfactory values, procedures with sensor calibration are invited.

This is also suggested when changing the height or type of pole (it could be a change in straightness of the pole).

10. Calibrate – TS Module

The *Calibrate* menu, in the TS mode, contains the function to define the base station on a point or as free station.

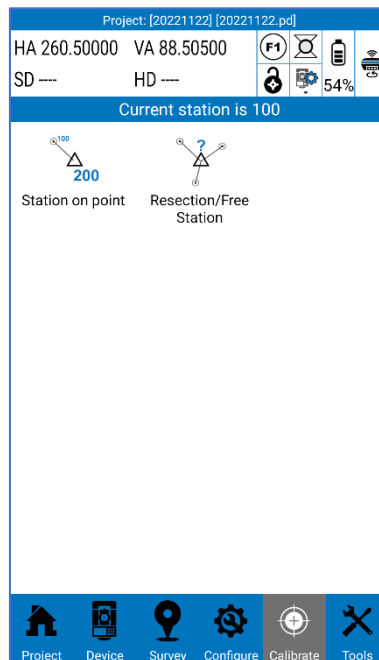

10.1 Station on point

Click Calibrate -> station on point: the screen in the figure below will be shown.

Station point coordinates can be entered manually by filling in the *Est Nord* and *Elevation* boxes, or by using the following keys:



to measure with GNSS antenna (if available). By clicking on it, Cube-a collects GPS coordinates directly using topographic point mode.



to select from the map including CAD entities



to select from the points list

If you want to change the name of the point, change the box to the left of these icons.

Enter the *Tool Height* (Total Station Height).



Station on point

HA 354.00000 VA 95.87500

SD — HD —

No active station

Setting up a station on a known point. Orientation direction can be measured, set to a specific azimuth angle or ignored (if setting up the first station of the survey).

Station point

Instrument height

Easting

Northing

Elevation

Elevation

Given above

From observation of a ref. point

Cancel Next

The elevation can also be inserted as a measure to a reference point. Define the reference point in the same way as it was done for the station point and insert the height of the target, then measure it and click *Next*.

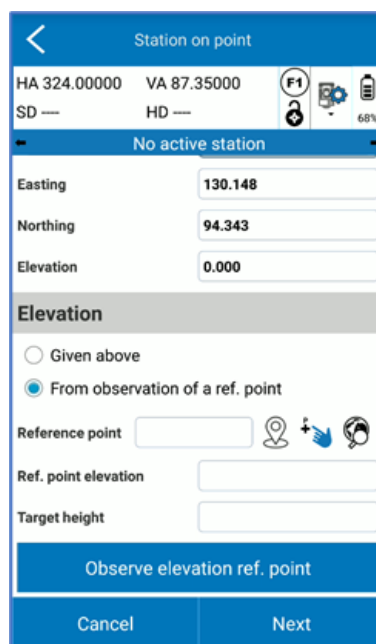

Station on point

HA 324.00000 VA 87.35000

SD — HD —

No active station

Easting 130.148

Northing 94.343

Elevation 0.000

Elevation

Given above

From observation of a ref. point

Reference point

Ref. point elevation

Target height

Observe elevation ref. point

Cancel Next

On the next page, define which orientation mode you want to use:

- *To a known point*: to orient the station to a point whose coordinates are known. Enter the coordinates of a point or measure or select it from the project (in the same way as defining the station point) and enter the height of the target.

- *By azimuth*: allows the input of an orientation azimuth. Enter the reference angle with respect to North of the local system (not to be confused with the horizontal angle/azimuth read by the instrument).
- *No orientation*: does not consider the orientation. By default, Cube-a uses the horizontal angle of the station, without zeroing it or setting it to a certain value.

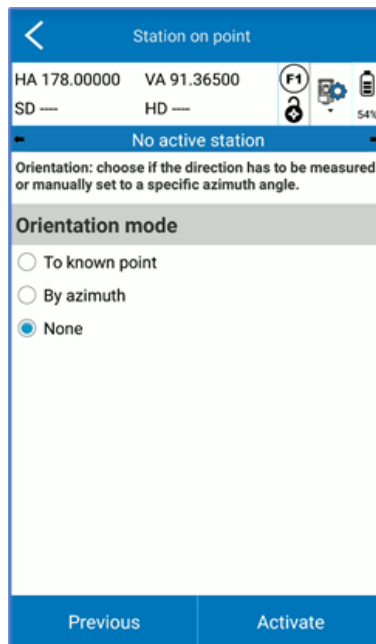
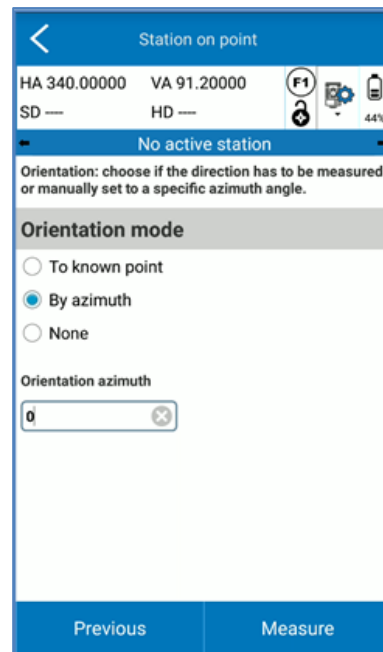
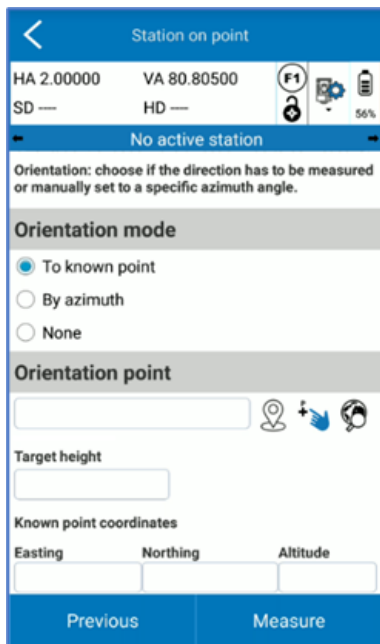

If you have selected *No Orientation*, you can click directly on *Activate* and you will complete the Station-by-Point procedure. Otherwise, in the other two cases, you have to click *Measure* and collect the measurement of the orientation point

1. *Force HA=0*: sets the horizontal angle to 0 (the vertical angle will be automatically forced to 100 gon).
2. *Set HA*: Sets the horizontal angle to a manually inserted value.
3. *Angles: measures: angles* from the instrument;
4. *Measure FULL*: measures the angles and distance from the instrument (Option available only in orientation towards known point).

Click OK, after measuring.

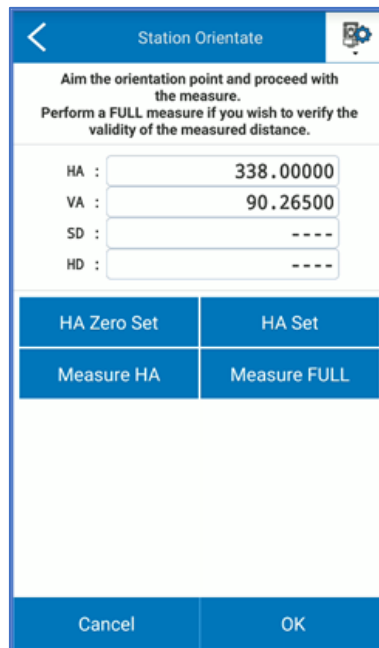

After the procedure, Cube-a asks for confirmation before activating the station on the defined point. Click Yes to proceed.

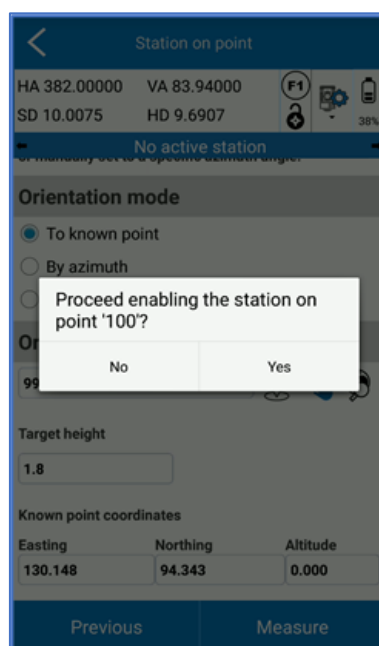

10.2 Resection/Free Station

Cube-a can calculate the position of a station on an unknown coordinate point.

Please note that the orientation/reference points should cover and be all around the stationing site. The location of the reference points limits the area where subsequent measurements should be carried out, using the stationing. Point capture and/or stake out should never be performed outside this area. If measurements occur towards points outside the area, orientation errors will be extrapolated (maximized) rather than interpolated (reduced).

Click Calibrate-> Free Station: the screen in the figure below will be shown.

Enter *Station Point Name* and *instrument high*.

Choose to check with scale factor or not. Enabling cube-a performs a check and applies an automatic factor over point distances so that the distances (at points) measured by the station are congruent.

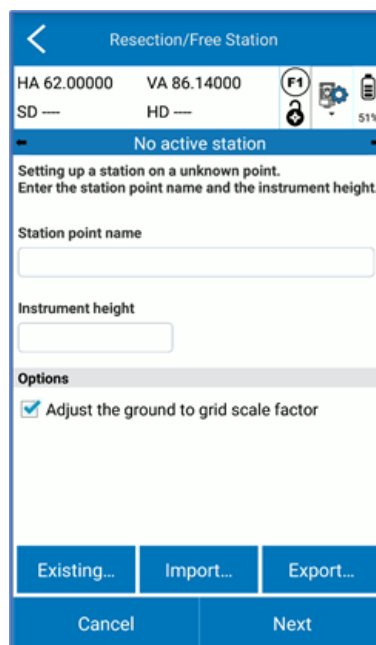

The *Import and Export* commands work with *.cr files, which store all stationing calculation, with the chosen points, station name, and each option entered performing this function.

Click Next to enter and measure the points for the least squares calculation. Cube-a requires you to satisfy one of the following cases:

- 3 or more angular readings.
- 2 or more complete readings (angles + distance).
- 2 or more mixed readings (angle + distance/ angles only).

Click New to insert the first point.



The coordinates of the point can be entered manually, either by filling in the *East*, *Nord* and *Elevation* box or by using the following keys:



to measure with GNSS antenna (if available). By clicking on it, Cube-a collects GPS coordinates directly using topographic point mode.



to select from the map, including CAD entities.



to select from the points list.

To change the name of the point, change the box to the left of the icons.

Insert the *Prism Height* (*pole height*) and click “Measure”

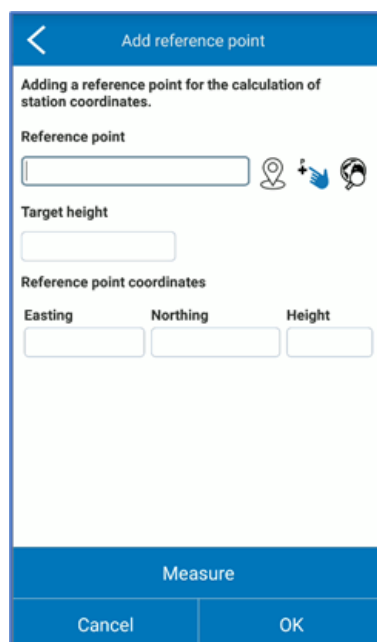

Aim the point and proceed with the measurement, which can be:

Angle measure: only angular measurement.

Complete Measure: angles and distance measurement.

Proceed by pressing OK.

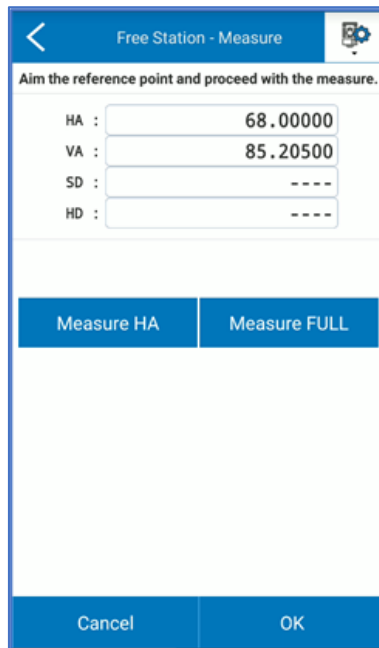

Free Station - Measure

Aim the reference point and proceed with the measure.

HA : 68.00000
 VA : 85.20500
 SD : ----
 HD : ----

Measure HA Measure FULL

Cancel OK

The first observation will be shown on the following page.



Resection/Free Station

HA 284.00000 VA 96.09500
 SD 10.0394 HD 10.0205

No active station

Reference points: add and measure at least 2 reference points to compute the station coordinates.

MEASURED REFERENCE POINTS

H	V	101	dH : ----
Pole: 1.80 PVDfs: 0.099 PC: 0.000 (Standard Prism)			dV : ----

Add Edit H V Delete

RESULTS

ADD AT LEAST 2 OBSERVED REF. POINTS

Previous OK

Continue with the addition of the next point(s), proceeding in the same way.

Then, you will be able to view the result of the calculations:

Calculated station coordinates E, N, Z.

Standard deviations of E, N, Z, which defines the estimation of the possible error on coordinates. They can be negative or positive values.

Residues on planimetric and vertical coordinates (Measured - Known). These are absolute values - values declared in meters.

dH is the difference between calculated and known point in 2D.

dV is the difference in altitude between calculated and known point.

Scale factor shows the calculated value.

Azimuth correction is the horizontal angle correction that the free station program calculates relative to the horizontal circle of the total station.

If you want, you can press on **H** and **V** to turn off Horizontal and/or Vertical reading and check if the quality of the result increases. The same command is carried out by *H* and *V* in the blue icons.

You can click *Edit* to modify a point and re-measure it. Or you can press on *Delete* to remove a point.

Before confirming with *OK*, you can press *Previous* to return to the screen where you can export the free station calculation.

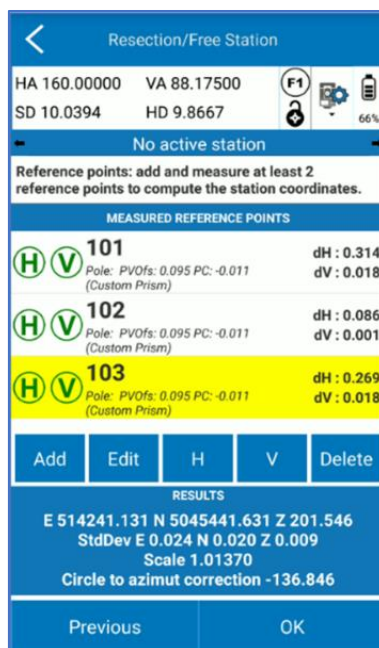

The free station file is exported with a *.cr extension:

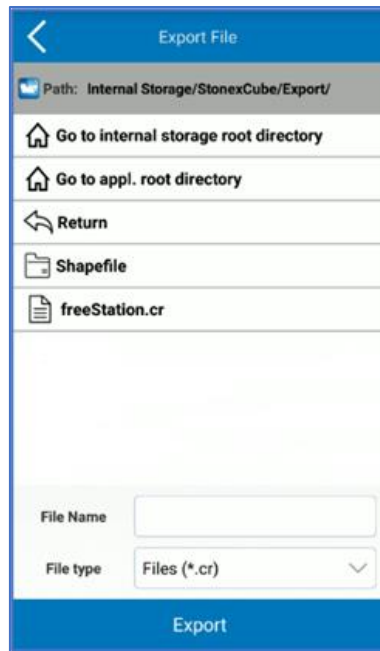

11. Tools

The *Tools* menu contains many useful functions such as volume and COGO calculations and information about the version and personal license of the Cube-a software.

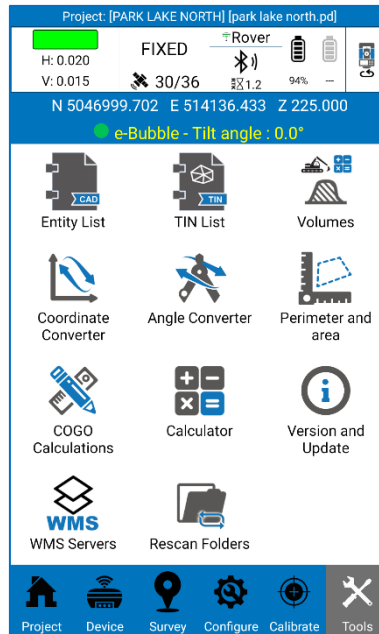

The *Calculator* submenu directly invokes the calculator within Cube-a software.

11.1 Entity List

The *Entity List* submenu contains the list of the CAD entities imported or created in Cube-a. As you can see in the following figure, the TIN are also CAD entity that you can find in this list.

No.	Name	G	Type	Color
20	PL-1		SQUARE	BY LAY
19	PL-1		SQUARE	BY LAY
18	PL-1		RECT CENTER+MID P...	BY LAY
17	PL-1		POLYLINE	BY LAY
16	TR-1		TRIANGLE	BY LAY
15	TR-1		TRIANGLE	BY LAY
14	PL-1		POLYLINE	BY LAY
13	PL-1		POLYLINE	BY LAY
12	PL-1		PARCEL	BY LAY
11	PL-1		POLYLINE	BY LAY
10	PL-1		POLYLINE	BY LAY
9	TIN2		TIN	BY LAY
8	PL-1		POLYLINE	BY LAY
7	PL-1		POLYLINE	BY LAY
6	PL-1		POLYLINE	BY LAY

Select the entity and click *Delete* to delete definitively the entity.

Click OK to exit the menu.

Select the entity and click *Edit* to edit one or more of the following properties:

- Name
- Code
- Layer
- Color
- Line type
- Make closed or open (if you select a polygon)
- GIS data
- TIN properties (see [11.2 TIN List](#))

11.2 TIN List

This page contains the list of the TIN (Triangulated Irregular Network). This feature is available with the module 3D only. Each TIN model in *TIN model list* corresponds to a TIN entity, that you can see in the survey area (if you delete the TIN entity then delete the TIN model also).

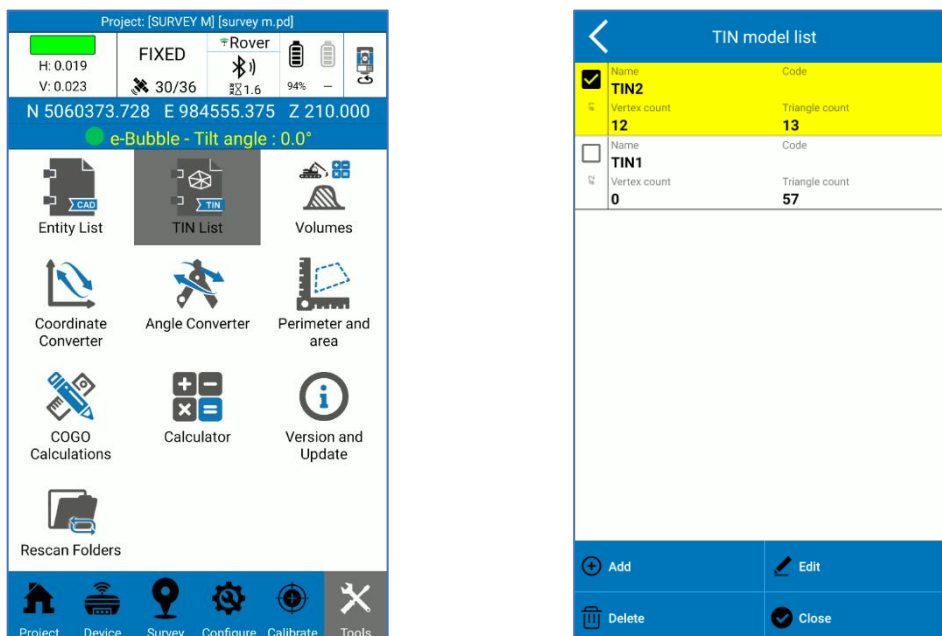

In the *TIN model list* page, you can select an existing TIN to edit its properties or to delete it.

Click *Add* to add a new TIN model; the following page appears.

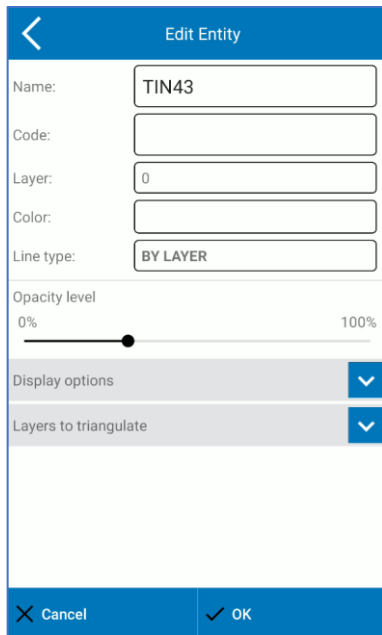

Edit Entity

Name:

Code:

Layer:

Color:

Line type:

Opacity level
0% 100%

Display options

Layers to triangulate

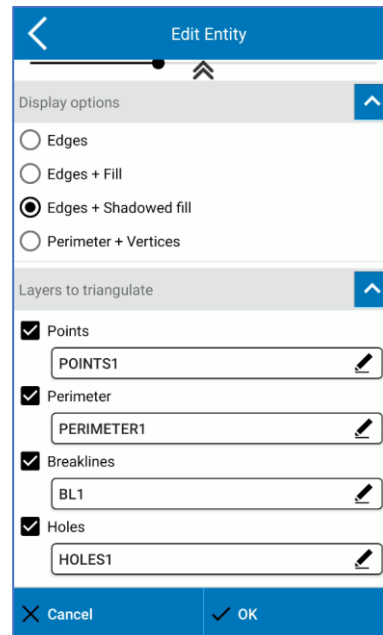

Edit Entity

Display options

Edges

Edges + Fill

Edges + Shadowed fill

Perimeter + Vertices

Layers to triangulate

Points

Perimeter

Breaklines

Holes

You can edit all the properties in the figures above, even for already existing TIN. They are dynamic so you can see in the survey area the changes in real time.

In *Layers to triangulate* section, you can choose layer for points, perimeter, break lines and holes to triangulate automatically.

You can even leave all these options disable. In this case, the TIN will be drawing only when you select TIN entity in the Survey area. See the following examples.

Example 1: *Layers to triangulate* enabled (page 125).

Example 2: *Layers to triangulate* disabled (page 126).

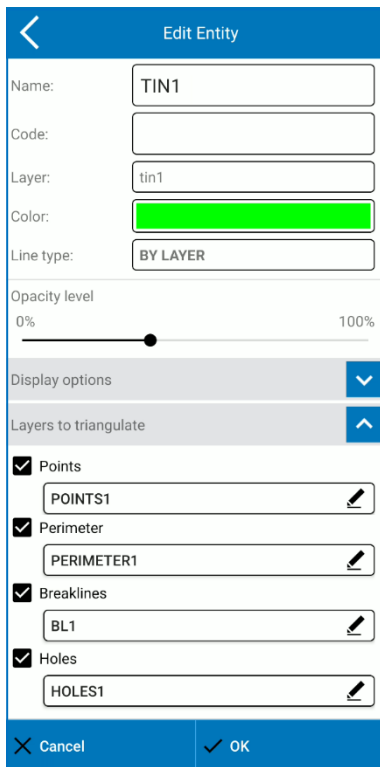

Example 1

The TIN1 will be drawing in the layer tin1, green.

- All points in the layer POINTS1 will be automatically triangulated with TIN1 during the survey.
- All closed entities in the layer PERIMETER1 will be automatically used as perimeter for TIN1 during the survey.
- All lines in the layer BL1 will be automatically used as breaklines for TIN1 during the survey.
- All closed entities in the layer HOLES1 will be automatically used as exclusions for TIN1 during the survey.



Below the layers settings and the TIN entity.

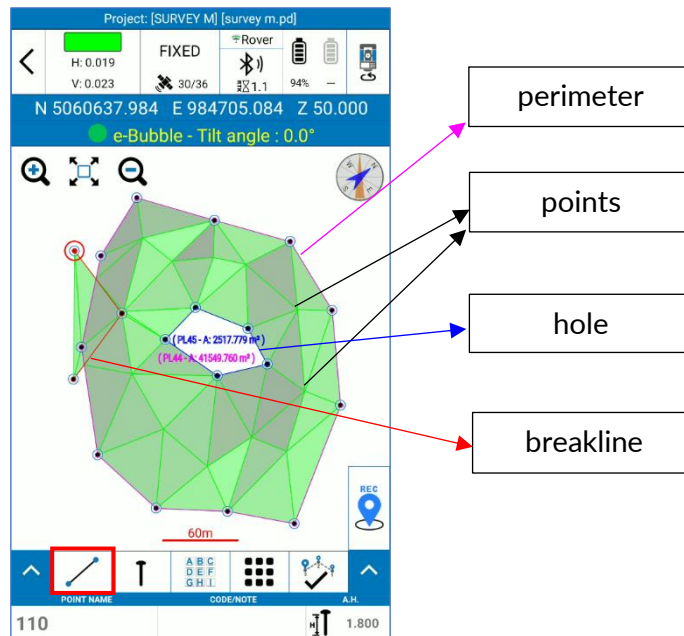
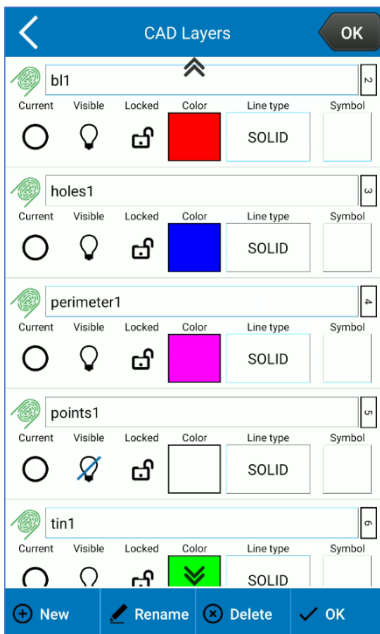

You can collect points or entities and the software automatically creates the TIN when the points or entities belong to the layers you have chosen in *Layers to triangulate*.

Edit Entity

Name: TIN2

Code:

Layer: tin2

Color:

Line type: BY LAYER

Opacity level: 0% ————— 100%

Display options: ▼

Layers to triangulate: ▲

Points: 0

Perimeter: 0

Breaklines: 0

Holes: 0

Cancel OK

Example 2

The TIN2 will be drawing in the layer tin2, yellow.

The TIN2 will not be automatically drawing during the survey because there are not layers to triangulate enabled, in the *Layers to triangulate* section.



To draw the TIN2 you must select TIN entity in the Survey area. Only if the TIN entity drawing is enabled, the collected point will be triangulated.

Below are shown

- TIN entity function enabled
- TIN2 with edges + shadowed fill
- TIN2 with only edges

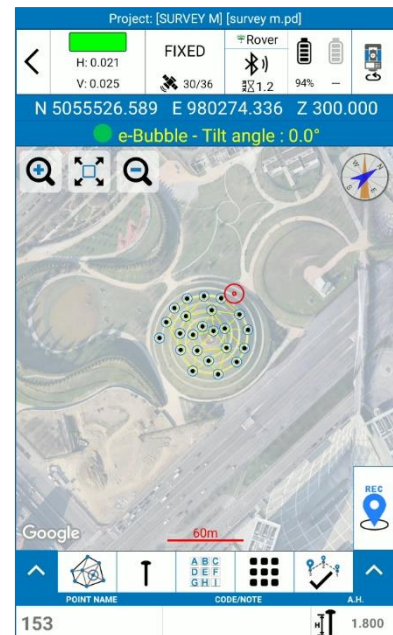
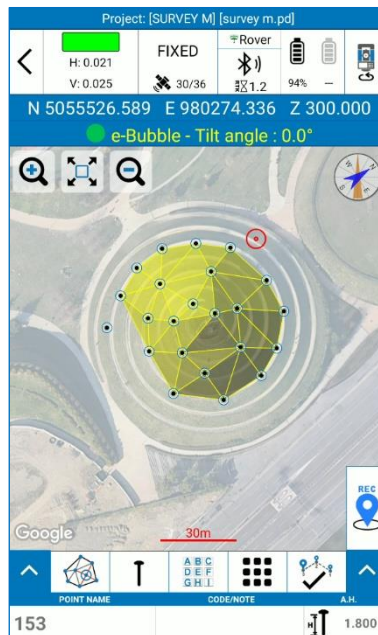
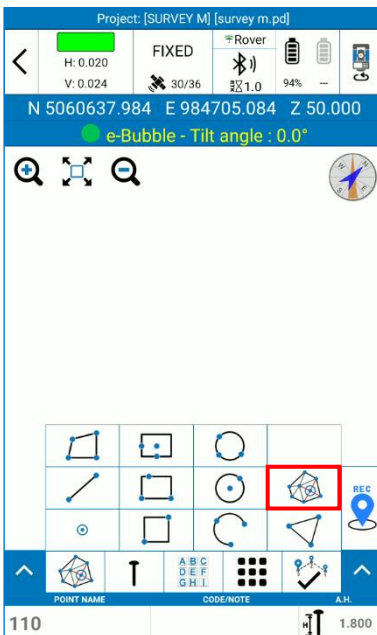

11.3 Volumes

This page contains the list of the volumes defined by the user. You can see the cut and fill volume and the 2D and 3D area for each volume, updated in real time. This feature is available with the module 3D only.

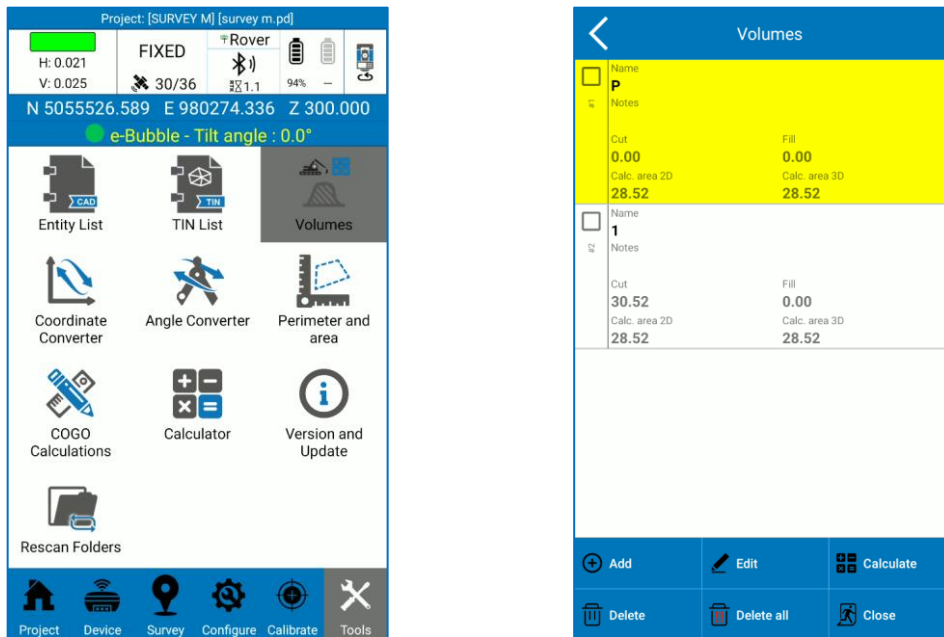

In the *Volumes* page, you can select an existing Volume to edit its properties or to delete it.

Click *Add* to add a new Volume; the following page appears.

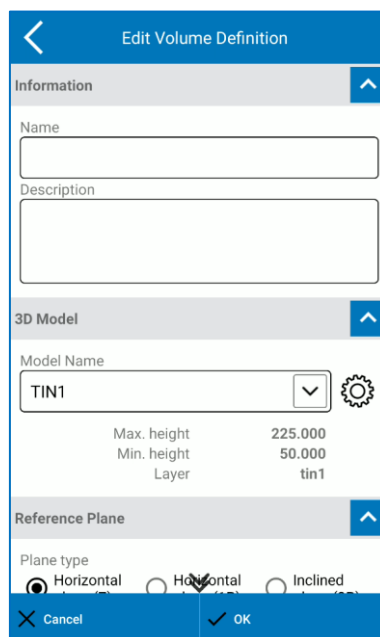

The 'Edit Volume Definition' form contains the following sections:

- Information:** Name (text input), Description (text input).
- 3D Model:** Model Name (dropdown menu showing 'TIN1'), Max. height (225.000), Min. height (50.000), Layer (tin1).
- Reference Plane:** Plane type (radio buttons for Horizontal, Horizontal, Inclined).

In the *Edit Volume Definition* page, you must insert a name for the volume that you are going to define, and you can insert a description (e.g., to remind the reason of the volume calculation).

The volume is calculated between a 3D model, so a TIN, and a reference plane.

You can select an existing TIN from dropdown menu or create a new one by clicking on the gear icon. See [11.2 TIN List](#) for details on TIN creating.

The reference plane can be horizontal or inclined. You can define the height of the horizontal plane in two ways described below. For each plane type, you can set an initial cut or fill volume.

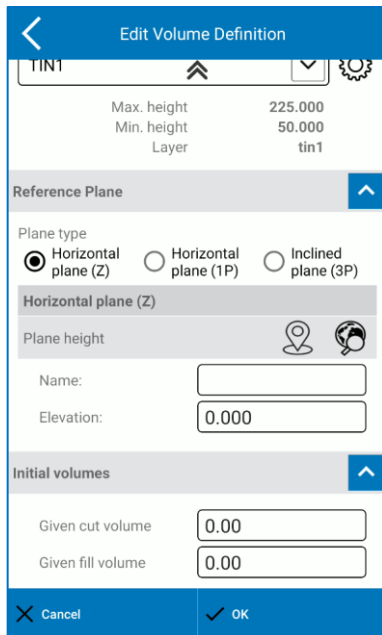

Edit Volume Definition

TIN1

Max. height: 225.000
Min. height: 50.000
Layer: tin1

Reference Plane

Plane type:
 Horizontal plane (Z)
 Horizontal plane (1P)
 Inclined plane (3P)

Horizontal plane (Z)

Plane height:
Name:
Elevation:

Initial volumes

Given cut volume:
Given fill volume:

Cancel OK

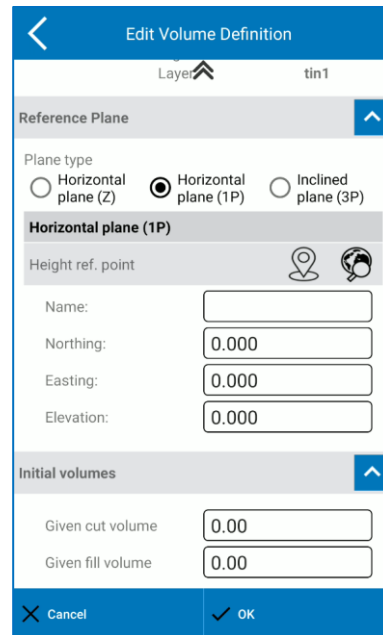

Edit Volume Definition

Layer tin1

Reference Plane

Plane type:
 Horizontal plane (Z)
 Horizontal plane (1P)
 Inclined plane (3P)

Horizontal plane (1P)

Height ref. point:
Name:
Northing:
Easting:
Elevation:

Initial volumes

Given cut volume:
Given fill volume:

Cancel OK

Horizontal plane (Z)

Define the horizontal plane by Z value. You can insert the Z value in the *Elevation* field or take from current GPS coordinates by clicking on REC button or take from a point in the library by clicking on searching button.

Horizontal plane (1P)

Define the horizontal plane by one point. Same as the previous option, but the application will also store the other 2 coordinates (Easting, Northing) for reference.

You can insert the point coordinates or take from current GPS coordinates by clicking on REC button or take from a point in the library by clicking on searching button.

Inclined plane (3P)

Define the inclined plane by 3 points. You can insert the points coordinates or take from current GPS coordinates by clicking on REC button or take from a point in the library by clicking on searching button.

11.4 Coordinate Converter

You can convert local coordinates to WGS84 geodetic coordinates and vice versa. Choose the conversion mode at the top and insert the coordinates in the section below in the format you chose. The section below depends on the conversion mode you select. It is possible to insert the coordinates manually, or to choose the point from the library by clicking the search icon (globe with lens) on the right. Once you have converted coordinates, there is the possibility to save the point in the points library.

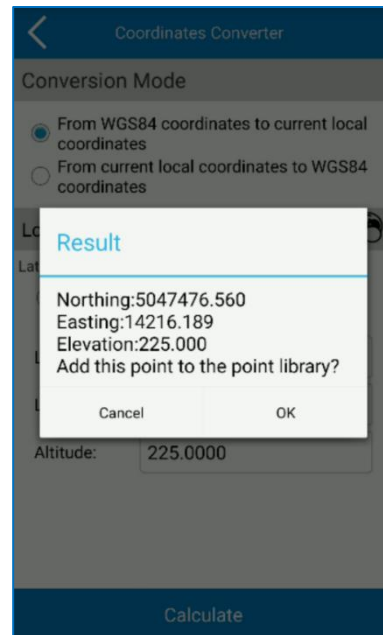
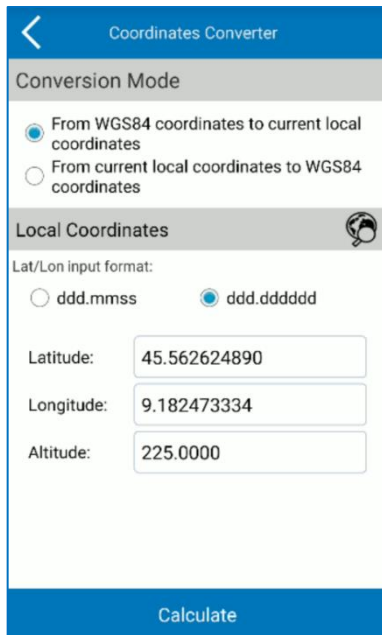

11.5 Angle Converter

There is the possibility to perform a conversion between different angle formats. Below, the procedure:

- Select the angle input format.
- Insert the angle value.
- Select the format in which you want to convert.

The value you enter will be automatically replaced by the angle value in the new format you choose.

In the example, the angle inserted is $45^{\circ}33'45.449604''$ in $dd^{\circ}mm'ss''$, the result converted to $dd.mmssss$ is shown in the figure on the right.

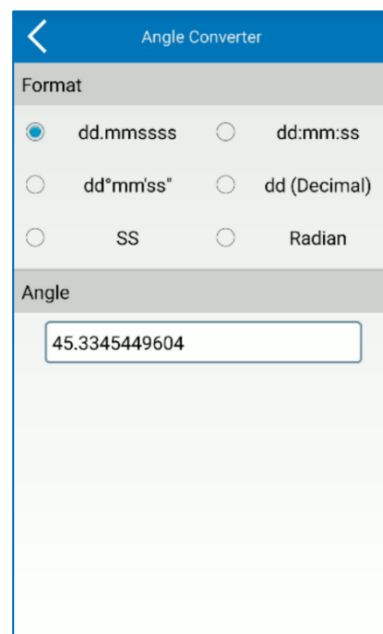
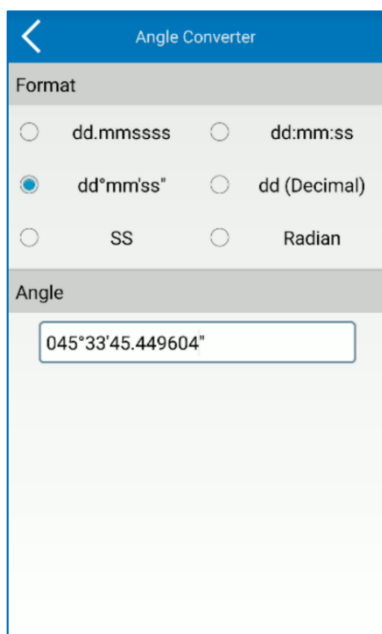

11.6 Perimeter and Area

It is possible to calculate the area and perimeter of entities obtained with certain points.

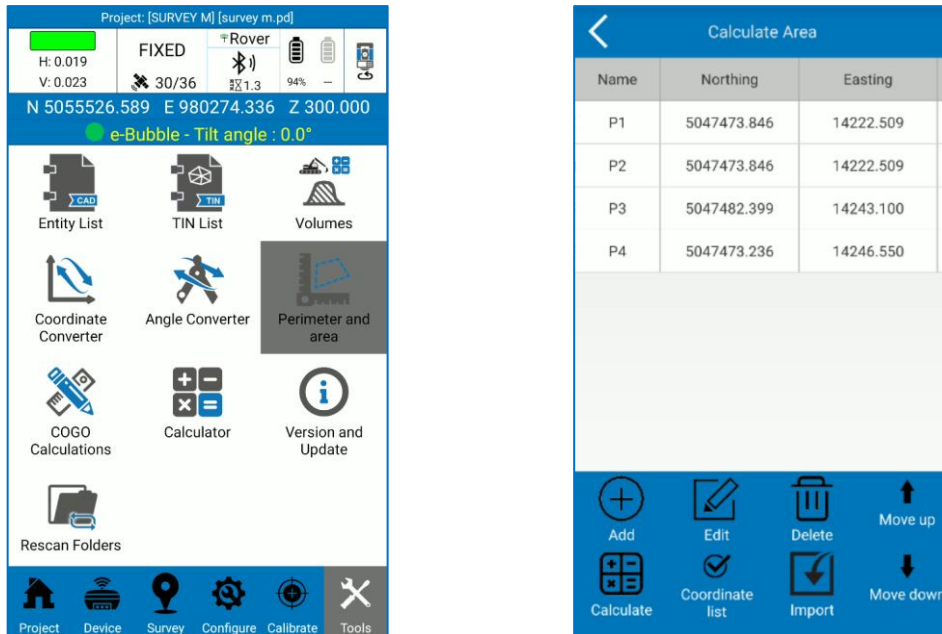

You must define the entity vertices. Click *Coordinate list* to access to the existing point list. Click *Add* to insert manually the coordinates, to select the points from survey area (*hand* icon), to take the coordinates from GNSS receiver (*rec* icon) or select the points from the point library (*search* icon). Click *Import* to take coordinates from an external file (*.csv, *.dat, *.txt).

Once the points are added, you can see them in the *Calculate Area* window, and you can also change the order of the vertices with the commands *Move up* and *Move down*.

Click *Calculate* to perform the calculation; is not possible to save the results.

11.7 COGO Calculations

In the COGO Calculations page, you can find various geometric calculations. Within each command, at the top, there is a brief description of what you must insert to perform the calculation and what is the result.

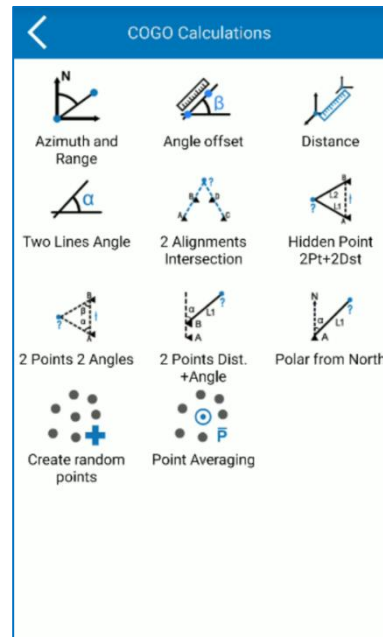

11.8 Version and Update

In this page you can read at the top the current version of the Cube-a installed on the device. Below, there are four keys.

- *Check for updates*: search for updates (internet connection is required); if a new version is available, a window will suggest downloading and installing the latest version.
- *Update info*: history of all releases with their respective bug fixes and implementations. Click *Search* to search by key word.
- *Activation info*: information about your personal license.
- *EULA*: End User License Agreement.

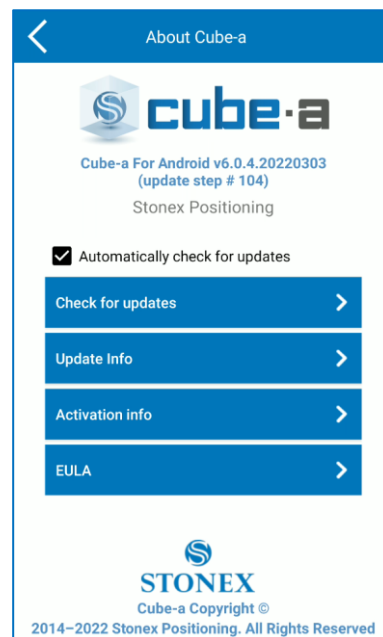
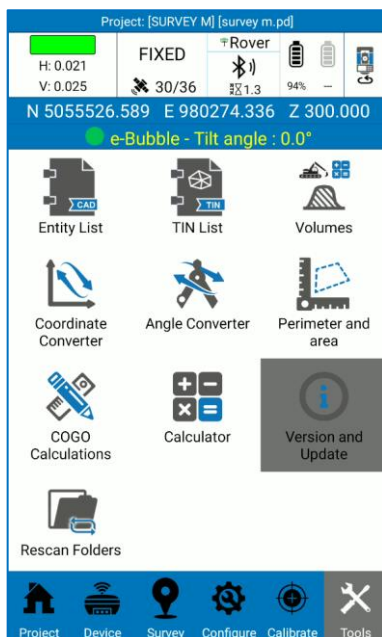

By clicking *Activation info*, you enter the following page. Here you can read your Cube-a license and the active modules (GPS/TS/GIS/3D).



Click *Export* below on the left to save your license in a txt file.

Click *Deactivate* to cancel the license. Export or copy the license before deactivation.

Warning: you can deactivate and register the purchased license on a different hardware at most three times. You cannot deactivate and register a demo license on a different hardware.

11.9 WMS Server





See

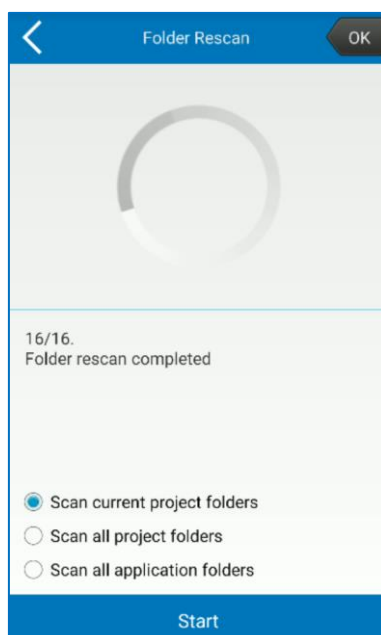

11.10 Rescan Folders



If you have problems viewing (to your PC) the Cube-a folders or files, or a particular project, you can force a scan of the current project folders, of all projects folders or of all Cube-a folders. Click *Start* to start the process.







12. Appendix A – CAD Tools



Function	Icons	Operating sequence
Multi selection from area		<p>Move the cursor over a vertex of the Entity bounding box and press [v].</p> <p>"Move the cursor to the opposite vertex of the Entity bounding box and press [v].</p> <p>If the second Vertex is to the right of the first Vertex (blue box), the Entities included entirely in the selection pane will be selected.</p> <p>If the second Vertex is to the left of the first Vertex (green box), the Entities included even partially in the selection pane will be selected."</p> <p>Then the MultiSelEach command (soon below) is automatically activated to allow you to add or remove individual Entities from the current selection.</p> <p>To end the selection command, move the cursor to an empty area and press [v].</p>
Multi selection from entities selection		<p>Move the cursor over each Entity to select and press [+] to add it or [-] to remove it.</p> <p>To end the selection command, move the cursor to an empty area and press [v].</p>
Multi selection from list		<p>The list of Entities in the current Project is displayed.</p> <p>Indicate the Entity to select and press the OK button</p>
Cancel selection		<p>Selecting this command will remove each selection.</p>
Move points		<p>Move the cursor to each Point you want to move and press [+] to select it. Press [-] to deselect it.</p> <p>Move the cursor to an empty area and press [v] to end the selection.</p> <p>Move the cursor to the first reference point and press [v] or [+].</p> <p>Move the cursor to the second reference point and press [v] or [+].</p>





		<p>In the following dialog, confirm/change the Offset of Moving Points and press [v] to accept or [x] to cancel the command.</p> <p>Finally you can see the Moved Points. Press [v] to end the command.</p>
Move entities		<p>Move the cursor over each Entity you want to rotate and press [+] to select it. Press [-] to deselect it.</p> <p>Move the cursor to an empty area and press [v] to end the selection.</p> <p>Move the cursor to the first reference point and press [v] or [+].</p> <p>Move the cursor to the second reference point and press [v] or [+].</p> <p>In the following dialog, confirm/change the dot displacement offset and press [v] to accept or [x] to cancel the command.</p> <p>Finally you can see the Moved Points. Press [v] to end the command.</p>
Points rotate		<p>Move the cursor to each Point you want to move and press [+] to select it. Press [-] to deselect it.</p> <p>Move the cursor to an empty area and press [v] to end the selection.</p> <p>Move the cursor to the center point of rotation (corner vertex) and press [v] or [+].</p> <p>Move the cursor to another point on the initial witness line for rotation (first side of the corner) and press [v] or [+].</p> <p>Move the cursor to another point on the final witness line for rotation (second side of the corner) and press [v] or [+].</p> <p>In the following dialog, confirm/change the angle of rotation of the Points and press [v] to accept or [x] to cancel the command.</p> <p>Finally you can see the Moved Points. Press [v] to end the command.</p>
Entities rotate		<p>Move the cursor over each Entity you want to move and press [+] to select it. Press [-] to deselect it.</p>





		<p>Move the cursor to an empty area and press [v] to end the selection.</p> <p>Move the cursor to the center point of rotation (corner vertex) and press [v] or [+].</p> <p>Move the cursor to another point on the initial witness line for rotation (first side of the corner) and press [v] or [+].</p> <p>Move the cursor to another point on the final witness line for rotation (second side of the corner) and press [v] or [+].</p> <p>In the following dialog, confirm/change the angle of rotation of the Entities and press [v] to accept or [x] to cancel the command.</p> <p>Finally you can see the Moved Entities. Press [v] to end the command.</p>
Entities cut		<p>Move the cursor and indicate a first point of the cutting line and press [v] or [+].</p> <p>Move the cursor and point to a second point in the cutting line and press [v] or [+].</p> <p>Move the cursor over each Entity to be dissected and press [+] (to renew it press [-]).</p> <p>Move the cursor to an empty area and press [v] to end the selection.</p> <p>Finally, you can see the result of the operation and the number of New Entities created. Press [v] to end the command.</p>
Scale entities using a reference line of another object		<p>Move the cursor over each Entity you want to scale and press [+] to select it. Press [-] to deselect it.</p> <p>Move the cursor to an empty area and press [v] to finish the selection.</p> <p>Move the cursor to one of the Vertices of the Entities to be scaled to select a reference segment and press [v].</p> <p>Move the cursor to a second Vertex of the Entities to be scaled to finish selecting the reference segment and press [v].</p> <p>Move the cursor to a segment vertex that represents the new length of the reference segment above and press [v].</p>





		<p>Move the cursor to the second vertex of the segment that represents the new length of the reference segment previously indicated and press [v].</p> <p>Finally you can see the result of the Scala operation. Press [v] to end the command.</p>
<p>Scale entities changing the length of the baseline</p>		<p>Move the cursor over each Entity you want to scale and press [+] to select it. Press [-] to deselect it.</p> <p>Move the cursor to an empty area and press [v] to end the selection.</p> <p>Move the cursor to one of the Vertices of the Entities to be scaled to select a reference segment and press [v].</p> <p>Move the cursor to a second Vertex of the Entities to be scaled to finish selecting the reference segment and press [v].</p> <p>In the following dialog, enter the new distance to be taken by the previously selected segment and press OK.</p> <p>Finally you can see the result of the Scala operation. Press [v] to end the command.</p>
<p>Scale entities by the percentage of the baseline</p>		<p>Move the cursor over each Entity you want to scale and press [+] to select it. Press [-] to deselect it.</p> <p>Move the cursor to an empty area and press [v] to end the selection.</p> <p>Move the cursor to the Point that will be the Reference Base Point to scale the selected Entities and press [v].</p> <p>In the following dialog, enter the new scale for the selected Entities and press OK.</p> <p>Finally you can see the result of the Scala operation. Press [v] to end the command.</p>
<p>Align entities</p>		<p>Move the cursor over each Entity you want to align and press [+] to select it. Press [-] to deselect it.</p> <p>Move the cursor to an empty area and press [v] to end the selection.</p>

		<p>Move the cursor to the Point that will be the Reference Base Point for the rotation of the selected Entities and press [v].</p> <p>Move the cursor to a second Point to indicate the segment to be made parallel to the witness line that will be selected later and press [v].</p> <p>Move the cursor to a first point on the witness line to which to align the selected Entities and press [v].</p> <p>Move the cursor to a second point on the witness line to which to align the selected Entities and press [v].</p> <p>Infine è possibile vedere il risultato dell'operazione di Allineamento. Premere [v] per terminare il comando.</p>
Align entities and base point		<p>Move the cursor over each Entity you want to align and press [+] to select it. Press [-] to deselect it.</p> <p>Move the cursor to an empty area and press [v] to end the selection.</p> <p>Move the cursor to the Point that will be the Reference Base Point for the rotation of the selected Entities and press [v].</p> <p>Move the cursor to a second Point to indicate the segment to be made parallel to the witness line that will be selected later and press [v].</p> <p>Move the cursor to a first point on the witness line to which to align the selected Entities and press [v].</p> <p>Move the cursor to a second point on the witness line to which to align the selected Entities and press [v].</p> <p>Finally, you can see the result of the Alignment operation. Press [v] to end the command.</p>
Aligne and overlap entities		<p>Move the cursor over each Entity you want to align and press [+] to select it. Press [-] to deselect it.</p> <p>Move the cursor to an empty area and press [v] to end the selection.</p> <p>Move the cursor to the Point that will be the Reference Base Point for the rotation of the selected Entities and press [v].</p>

		<p>Move the cursor to a second Point to indicate the segment to be made parallel to the witness line that will be selected later and press [v].</p> <p>Move the cursor to a first point on the witness line to which to align the selected Entities and press [v].</p> <p>Move the cursor to a second point on the witness line to which to align the selected Entities and press [v].</p> <p>Finally, you can see the result of the Alignment operation. Press [v] to end the command.</p>
Entity offset		<p>Move the cursor over the Reference Entity from which to create the Offsets and press [v].</p> <p>Move the cursor to the side where you want to create the new Offset Entities and to the distance that will indicate the step between the new Entities and press [v].</p> <p>In the following dialog, confirm/modify respectively the distance between the new Entities, the Δ dimension and the number of new Entities to be created and press [v].</p> <p>Finally, you can see the result of the Offset operation. Press [v] to end the command.</p>
New points along a parallel line, from offset and step		<p>Move the cursor to indicate the first point on the witness line and press [v] or [+].</p> <p>Move the cursor to indicate the second point on the witness line and press [v] or [+].</p> <p>Move the cursor to indicate the location of the first point in the series to be created and press [v] or [+].</p> <p>In the following dialog, confirm/modify the Square and Distance values of the first point to be created and press [v].</p> <p>Move the cursor to indicate direction and pitch of the new Points to be created and press [v].</p> <p>In the following dialog, confirm/edit Step, Δ Quota and Number of new Points to create and press [v].</p> <p>Finally, you can see the result of the Point Offset operation along a parallel. Press [v] to end the command.</p>

<p>New points from angle and offset</p>		<p>Move the cursor to indicate the first point on the witness line and press [v] or [+].</p> <p>Move the cursor to indicate the second point on the witness line and press [v] or [+].</p> <p>In the following dialog, enter Angle, Distance, Square, and Δ Dimension of the new Point and press [v].</p> <p>Finally you can see the result of the Operation of Offset Point from Angle-Distance-Square. Press [v] to end the command.</p>
<p>Entity spacing</p>		<p>Move the cursor over each Entity you want to Translate and press [+] to select it. Press [-] to deselect it.</p> <p>Move the cursor to an empty area and press [v] to end the selection.</p> <p>Move the cursor to the first reference point to calculate the new distance and press [v] or [+].</p> <p>Move the cursor to the second reference point to calculate the new distance and press [v] or [+].</p> <p>In the following dialog, confirm/modify the new distance between the 2 points to translate the selected Entities along the indicated direction and press [v].</p> <p>Finally you can see the result of the Translation operation. Press [v] to end the command.</p>
<p>Entities mirror</p>		<p>Move the cursor over each Entity from Mirror and press [+] to select it. Press [-] to deselect it.</p> <p>Move the cursor to an empty area and press [v] to end the selection.</p> <p>Move the cursor to the first Reference Point of the mirror line and press [v] or [+].</p> <p>Move the cursor to the second Reference Point of the mirror line and press [v] or [+].</p> <p>Finally you can see the result of the Mirror operation. Press [v] to end the command.</p>
<p>Extend entities</p>		<p>Move the cursor over the Line that identifies the extension limit of the ends of the selected Entities and press [v].</p>

		<p>Move the cursor over each Entity whose ends you want to extend and press [+] to select it. Press [-] to deselect it.</p> <p>Move the cursor to an empty area and press [v] to finish selecting Entities and execute the command.</p> <p>Finally you can see the result of the Extension operation. Press [v] to end the command.</p>
Insert vertex		<p>Move the cursor to the side of the Polyline where you want to add the new Vertex and press [v].</p> <p>Move the cursor to the point where you want to insert the new Vertex and press [v] or [+].</p> <p>In the following dialog, confirm/change the coordinates of the new Vertex and press [v].</p> <p>Finally, you can see the result of the Vertex Insertion operation. Press [v] to end the command.</p>
Delete vertex		<p>Move the cursor to the Vertex of the Polyline to be deleted and press [-].</p> <p>Finally you can see the result of the Summit Erase operation. Press [v] to end the command.</p>
Move vertex		<p>Move the cursor to the Vertex of the Polyline you want to move and press [v].</p> <p>Move the cursor to the new position where you want to move the Vertex and press [v] or [+].</p> <p>In the following dialog, confirm/change the new summit coordinates and press [v].</p> <p>Finally, you can see the result of the Vertex Shift operation. Press [v] to end the command.</p>
Copy entities		<p>Move the cursor over each Entity you want to copy and press [+] to select it.</p> <p>Move the cursor to an empty area and press [v] to end the selection.</p> <p>Move the cursor to the first reference point and press [v] or [+].</p> <p>Move the cursor to the second reference point and press [v] or [+].</p>

		<p>In the following dialog, confirm/modify the placement offset of the newly copied Entities and press [v] to accept or [x] to cancel the command.</p> <p>Finally you can see the copied Entities. Press [v] to end the command.</p>
Move entities on a different layer		<p>Move the cursor over each Entity you want to Move and press [+] to select it. Press [-] to deselect it.</p> <p>Move the cursor to an empty area and press [v] to end the selection.</p> <p>In the following dialog, indicate the new Layer where to move the selected Entities and press [OK].</p> <p>Finally you can see the Moved Entities. Press [v] to end the command.</p>
Delete entities		<p>Move the cursor over each Entity you want to Erase and press [+] to select it. Press [-] to deselect it.</p> <p>Move the cursor to an empty area and press [v] to end the selection.</p> <p>The following dialog prompts you to confirm the deletion operation of the selected Entities by pressing [v] to confirm or [x] to cancel.</p> <p>Finally you can see the result. Press [v] to end the command.</p>
Measure distance		<p>Move the cursor to indicate the first point of the segment to be measured and press [v] or [+].</p> <p>Move the cursor to indicate the second point of the segment to be measured and press [v] or [+].</p> <p>Finally you can see on the status bar the size of the Segment. Press [v] to end the command.</p>
Measure angle		<p>Move the cursor to indicate the vertex of the Angle to be measured and press [v] or [+].</p> <p>Move the cursor to indicate a point on the first side of the Angle to be measured and press [v] or [+].</p> <p>Move the cursor to indicate a point on the second side of the Angle to be measured and press [v] or [+].</p>

		Finally you can see on the status bar the size of the Angle. Press [v] to end the command.
--	--	--

13. Appendix B – Road Stakeout

It's possible to stakeout roads and, in general, geometries composed of straights, arches, clothoids and parabes, from Cube-a version 6.1. Click *Road Stakeout* to access the road library. If you have already selected a file from road library, then the road stakeout page will open as soon as you click Road Stakeout submenu; in this case,

click  to access the road library.

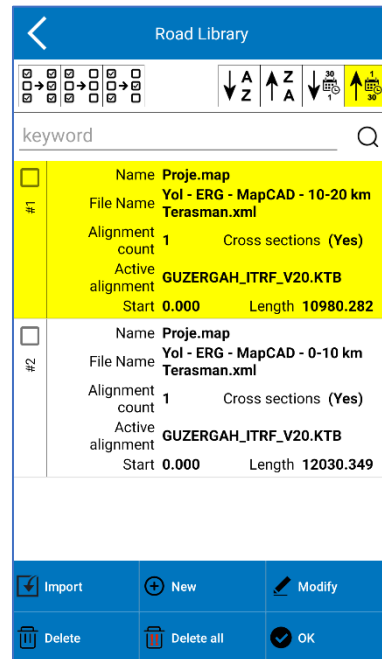
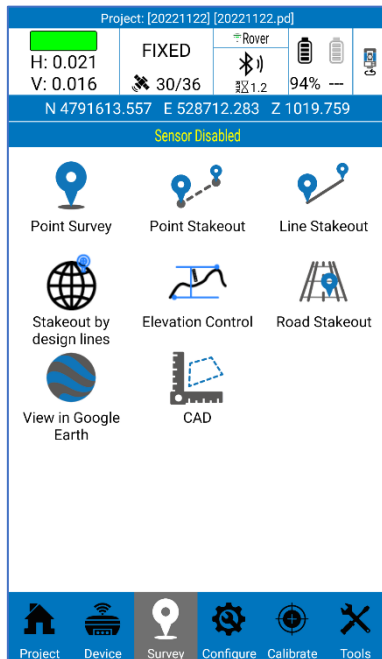

You can select or clear multiple roads at the same time and reverse selections using the selection icon in the upper left.

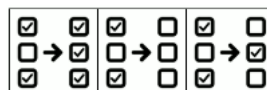

All roads can be sorted by name or acquisition date using the following icons in the upper right.



You can search the road by keyword.

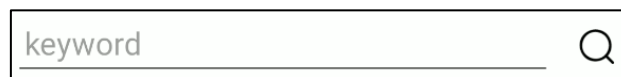

Click *Import* to import the road or road geometry to stakeout. The compatible formats are *.XML, *.DXF, *.CSV.

LandXML Import

The most complete format is LandXML, it can contain the planimetric track, the cross sections, and the elevation profile and 3D models by TIN.

DXF Import

The DXF format allows to import tracks and cross sections by polyline or LWpolyline so lines and arches and 3D models by TIN. When you import a DXF file the following window appears.

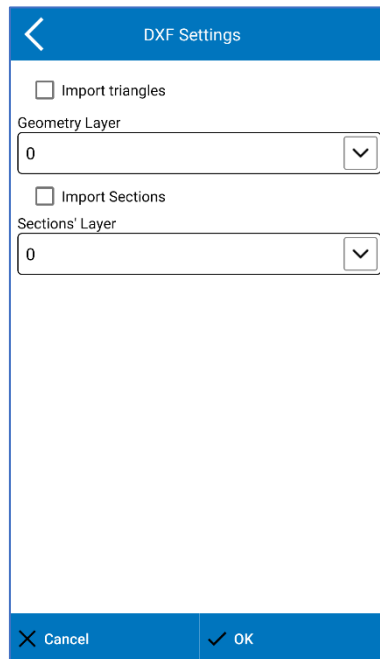

You can choose the destination layer for track and sections and if you want to also import the TIN or not.

CSV Import

The CSV format allows to import just one geometry as sequence of points in axis. When you import a CSV file the following window appears.

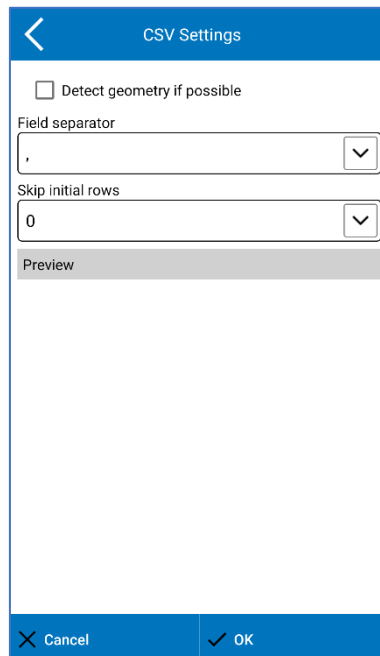

It shows a preview, the first lines of the file to remind what's the field separator and if there is a header to correctly set the number of initial lines to skip. Enable the option "Detect geometry if possible" to recognize straights and arches; this function works properly if the points come from discretization of a complex geometry.

Stakeout settings

Select the road from list and click OK to stakeout.

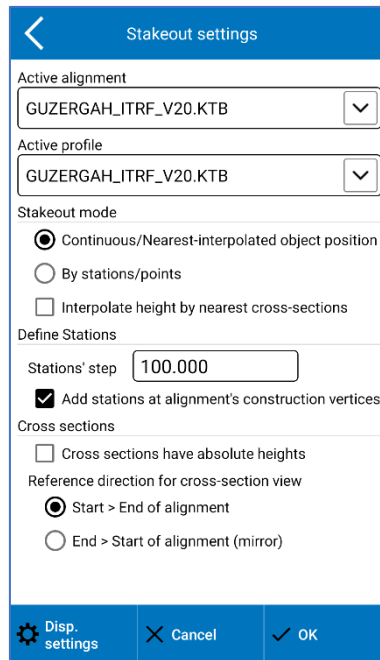

- ❖ Active alignment

Which alignment will be used for stakeout between the available ones.
- ❖ Active profile

Which elevation profile will be used.
- ❖ Stakeout mode: Continuous/nearest interpolated object position

The current gps position will be projected on the track to reach the nearest point.
- ❖ Stakeout mode: By stations/points

Reach the defined stations/points along the track.
- ❖ Interpolate height by nearest cross-sections

Calculate height by interpolation between the previous and next cross-sections.
- ❖ Stations step

Set the distance between each station along the track.
- ❖ Add stations at alignment's construction vertices

Add stations also on feature points of the track, like start and end of each junction of the track.
- ❖ Cross sections have absolute heights

If enabled, cross sections heights are absolute; if disabled cross sections heights are relative to the elevation profile so it's important, in this case, select the right profile.
- ❖ Reference direction for cross-section view

Mirror the section if the walking direction it's not the same of the road project direction (start->end)



Road Stakeout Interface

If you have already selected a file from road library, then the road stakeout page will open as soon as you click Road Stakeout submenu, otherwise, select the file and click OK to start the stakeout.

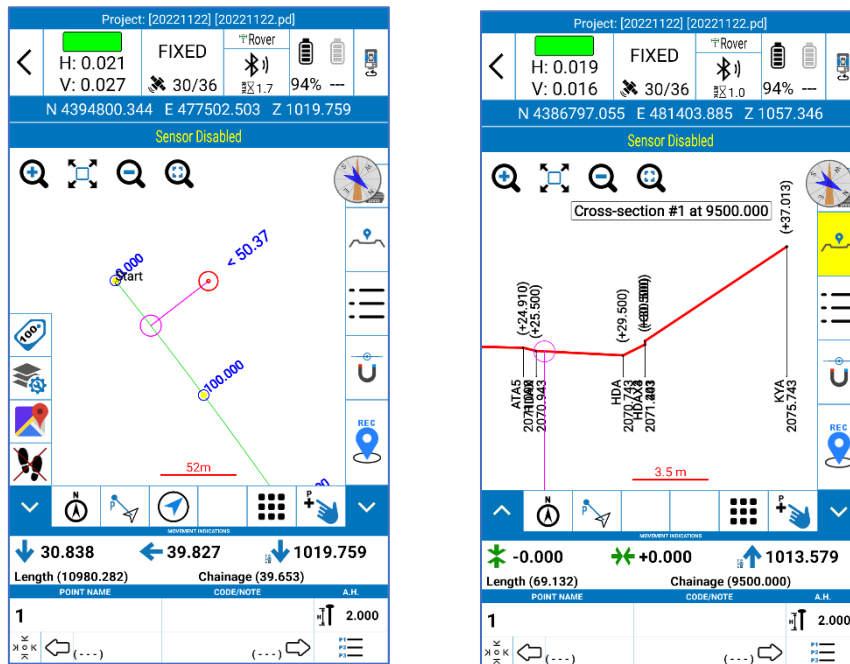
The interface is like the standard stakeout interface (see [6.2Point Stakeout](#)).



In the indication bar, in addition, there are the length and the chainage that is calculated from the projection of the current measure, and the following icons.

	Enable SNAP on the closest station point
	Go to section view (the closest available section) or back to profile view



STONEX® SRL

Via dell'Industria, 53 - 20037 Paderno Dugnano (MI)

Tel: +39 02 78619201

www.stonex.it